

ASSEMBLY INSTRUCTION FOR ACME FURNITURE





MODEL# 60170T/60171ST

Thank you for purchasing the quality product. Be sure to check all packing material carefully for small parts which may have come loose inside the carton during shipment. Separate, identify and count all parts and metal hardware. Compare with all parts list to be sure all parts are present. If any part(s) are missing or damaged, please contact your local furniture dealer. For efficient and speedy service, please indicate the model number and code letter of part(s) needed.

*****Do not fully tighten screws until fully assembled*****

DESCRIPTION	COMPONENT PARTS	
	PART NAME	Q'TY (PCS)
P1	TABLE TOP	1
P2	PEDESTAL LEG	2
P3	LEG BASE PANEL	2
P4	MOUNTING PLATE	2

HAREWARES REQUIRED

H1		JCBC BOLT M6 x 35MM - 24 PCS
H2		SPRING WASHER - 24 PCS
H3		FLAT WASHER - 8 PCS
H4		LEG ADJUSTABLE GLIDE - 8 PCS
H5		ALLEN KEY - 1 PC

Attention:

*** Some number parts listed on the instruction sheet may not be in parts bag as they may already be assembled. Carefully check parts and packing materials prior to ordering replacements.

How to assemble:

STEP 1

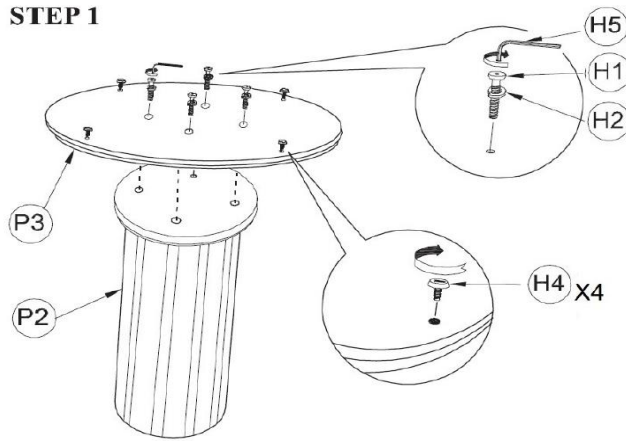

STEP 2

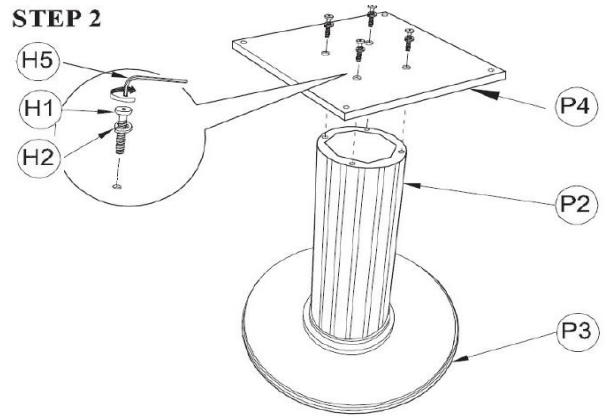

STEP 3

