

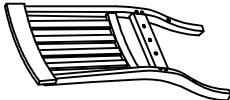

ASSEMBLY INSTRUCTIONS FOR ACME FURNITURE





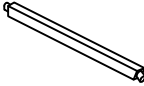
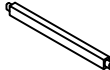
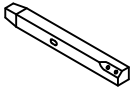

MODEL #61032

Thank you for purchasing the quality product. Be sure to check all packing material carefully for small parts which may have come loose inside the carton during shipment. Separate, identify and count all parts and metal hardware. Compare with all parts list to be sure all parts are present. If any part(s) are missing or damaged, please contact your local furniture dealer. For efficient and speedy service, please indicate the model number and code letter of part(s) needed.

Do not fully tighten screws until fully assembled

COMPONENT PARTS			
DESCRIPTION	PART NAME		Q'TY(PCS)
①	CHAIR BACK		1PC
②	SEAT FRAME		1PC
③	SIDE STRETCHER		1L,1R
④	FRONT STRETCHER		1PC
⑤	FRONT LEGS		1L,1R

HARDWARES REQUIRED

- Ⓐ

BOLTS $\frac{1}{4}$ " * 40mm - 2 PCS
- Ⓑ

BOLTS $\frac{1}{4}$ " * 60mm - 4 PCS
- Ⓒ

BOLTS $\frac{1}{4}$ " * 75mm - 4 PCS
- Ⓓ

SPRING WASHER $\frac{1}{4}$ " - 10 PCS
- Ⓔ

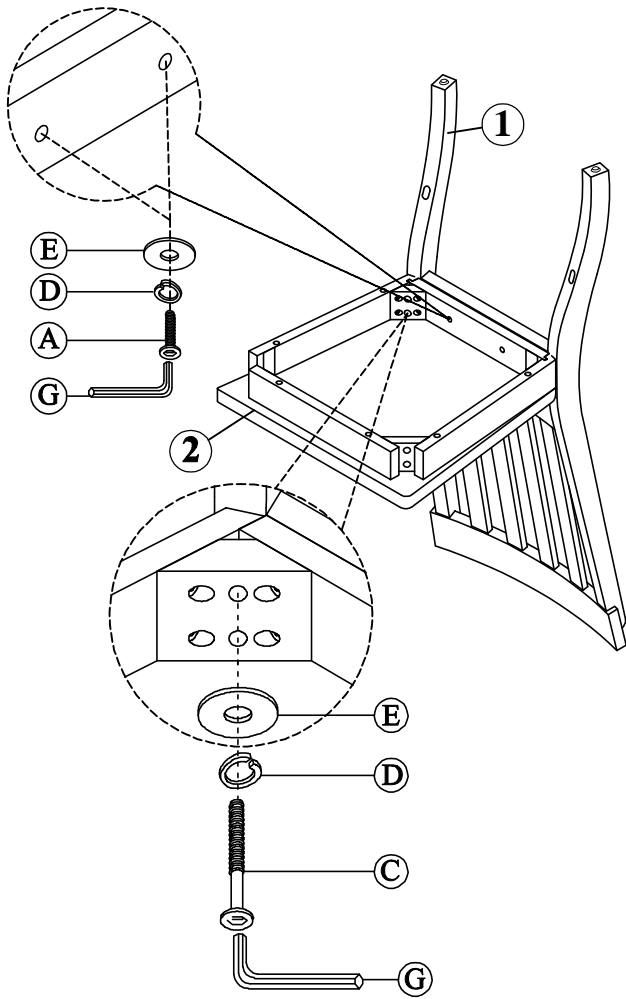
FLAT WASHER $\frac{1}{4}$ " * 19mm - 10 PCS
- Ⓕ

SCREW #4 x 38mm - 6 PCS
- Ⓖ

ALLEN KEY 4mm - 1 PC

Attention:

*** Some number parts listed on the instruction sheet may not be in parts bag as they may already be assembled. Carefully check parts and packing materials prior to ordering replacements.

How to assemble:

STEP 1



STEP 2

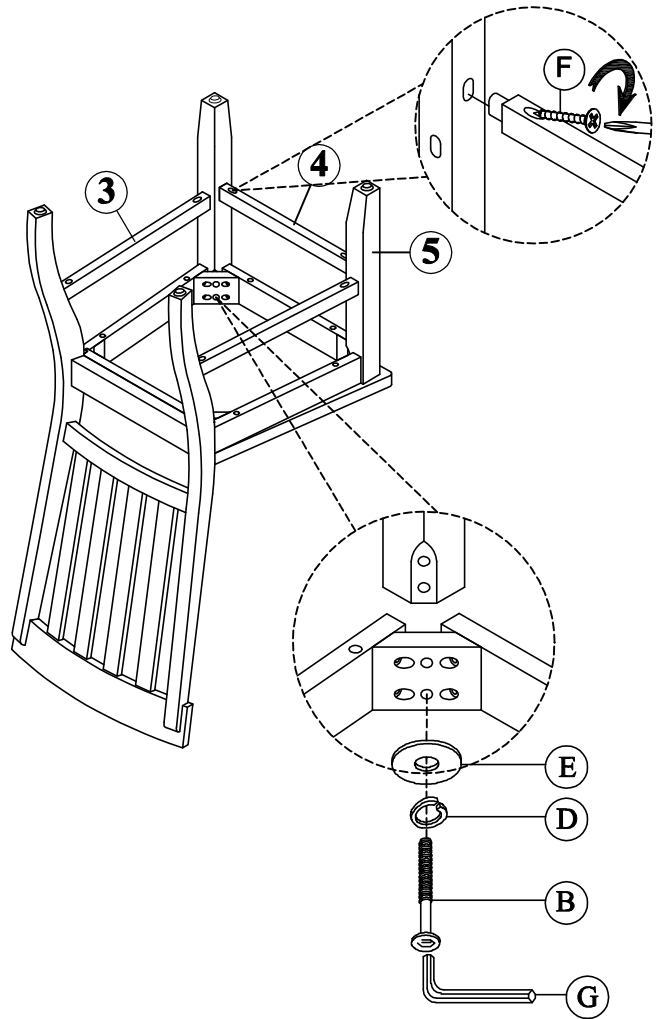

COMPLETED

