













ASSEMBLY INSTRUCTION FOR ACME FURNITURE

MODEL# 53745/54150/54155/53985

Thank you for purchasing this quality product. Be sure to check all packing material carefully for small parts which may have come loose inside the carton during shipment. Separate, identify and metal hardware. Compare with parts list to be sure all parts are present. If any part(s) are missing or damaged please contact your local furniture dealer. For efficient and speedy service, please indicate the model number and code letter of part(s) needed.

PARTS LIST

DESCRIPTION	DRAWING	PART NAME	QTY (PCS)
1		LEFT SEAT BASE	1
2		RIGHT SEAT BASE	1
3		MIDDLE BACK CUSHION	2
4		CONSOLE BACK CUSHION	1
5		WEDGE LEFT BACK CUSHION	1
6		WEDGE RIGHT BACK CUSHION	1
7		LEFT SEAT BASE	1
8		RIGHT SEAT BASE	1
9		MIDDLESEAT BASE	2
10		WEDGE SEAT	1
11		CONSOLE	1

HARDWARE LIST	DRAWING	PART NAME	QTY (PCS)
A		POWER CORD	2
B		EXTENSION CORD	2

STEP 1

Align the female brackets at the back onto the male brackets at the seat. insert back rest left and right to the seat and make sure it is fixed in position securely .

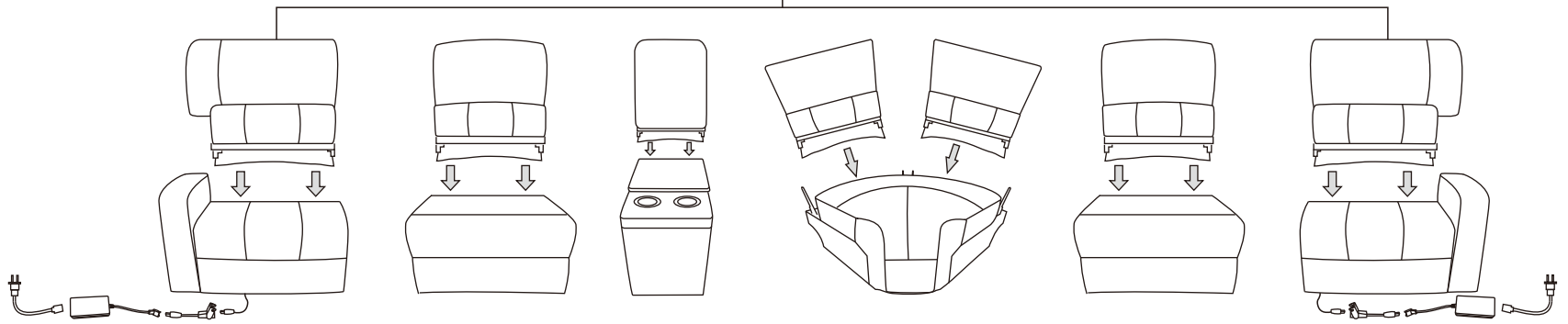
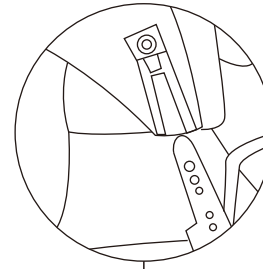

STEP 2

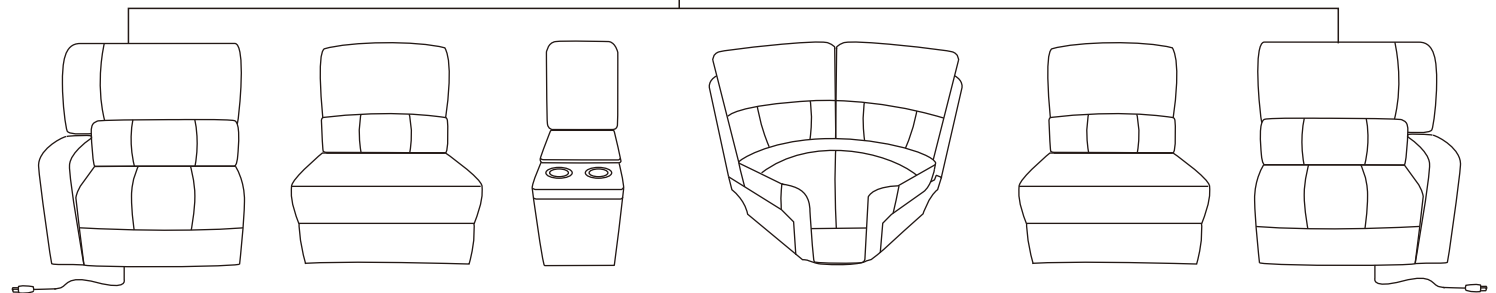
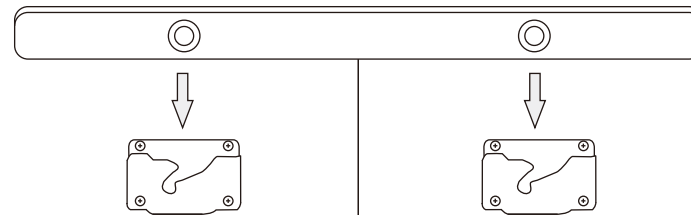

STEP 3

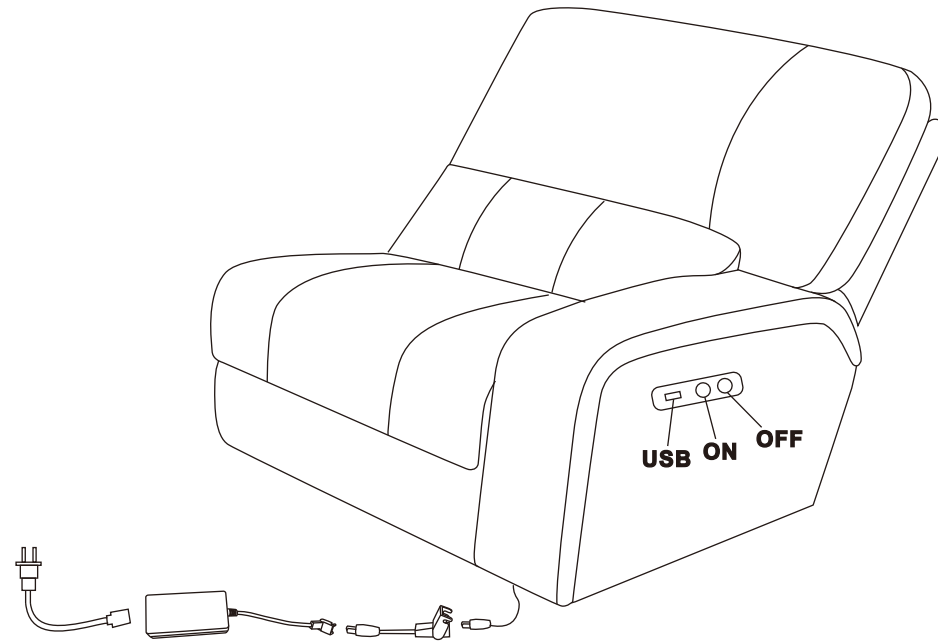

FINISH

