







ASSEMBLY INSTRUCTIONS FOR ACME FURNITURE MODEL#71855T/71856ST

Thank you for purchasing the quality product. Be sure to check all packing material carefully for small parts which may have come loose inside the carton during shipment. Separate, identify and count all parts and metal hardware. Compare with all parts list to be sure all parts are present. If any part(s) are missing or damaged, please contact your local furniture dealer. For efficient and speedy service, please indicate the model number and code letter of part(s) needed

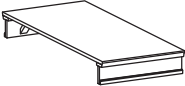
*** Do not fully tighten screws until fully assembled ***

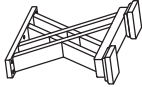
COMPONENT PARTS				HARDWARE REQUIRED			
NO	DESCRIPTION	SKETCH	QTY	NO	DESCRIPTION	SKETCH	QTY
Ⓐ	TABLE TOP		1 Pc	①	Bolt Ø5/16 * 38mm		12 Pcs
Ⓑ	TABLE LEAF		1 Pc	②	Spring Washer Ø5/16 * 13		12 Pcs
Ⓒ	TABLE LEG		2 Pcs	③	Flat Washer Ø5/16 * 19		12 Pcs
				④	Allen Key M4		1 Pc

Attention

Some number parts listed on the instruction sheet may not be in parts bag as they may be assembled. Carefully check parts and packing materials prior to ordering replacements.

STEP 1

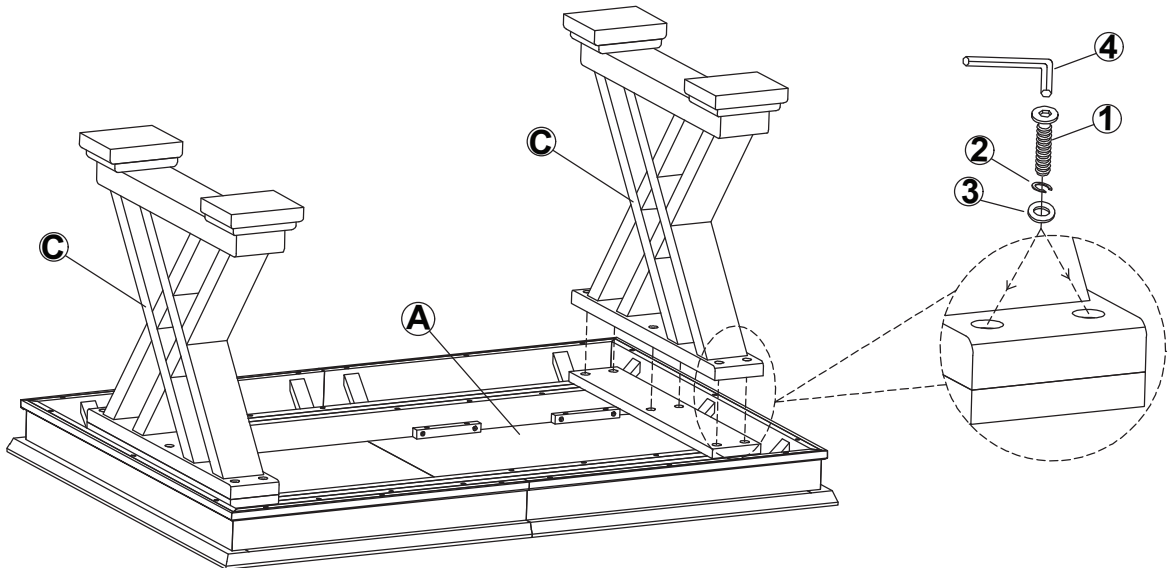

STEP 2

