

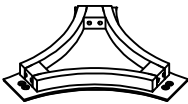







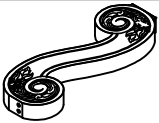

# ASSEMBLY INSTRUCTION

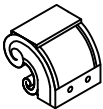
## MODEL: #61280/ 81 DINING TABLE

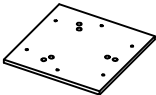
Thank you for purchasing this quality product. Be sure to check all packing material carefully for small parts which may have come loose inside the carton during shipment. Separate, identify and count all parts and metal hardware. Compare with parts list to be sure all parts are present. If any part(s) are missing or damaged, please contact your local furniture dealer. For efficient and speedy service, please indicate the model number and code letter of part(s) needed.

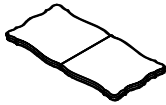
\*\*\* Do not fully tighten screws until fully assembled \*\*\*

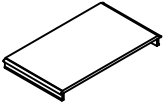
PARTS LIST				HARDWARE LIST			
NO	DESCRIPTION	SKETCH	QTY	NO	DESCRIPTION	SKETCH	QTY
A	BOTTOM FRAME		2PCS	1	ALLEN BOLT (Ø5/16*50MM)		36 PCS
B	PEDESTAL		6PCS	2	ALLEN BOLT (Ø5/16*70MM)		12 PCS
C	BUN FOOL		6PCS	3	LOCK WASHER (Ø5/16*2MM)		48 PCS
D	MOUNTING PANEL		2PCS	4	FLAT WASHER (Ø5/16*2MM)		48 PCS
E	TABLE TOP		1PC	5	ALLEN KEY (M4)		1 Pc
F	TABLE LEAF		1PC				

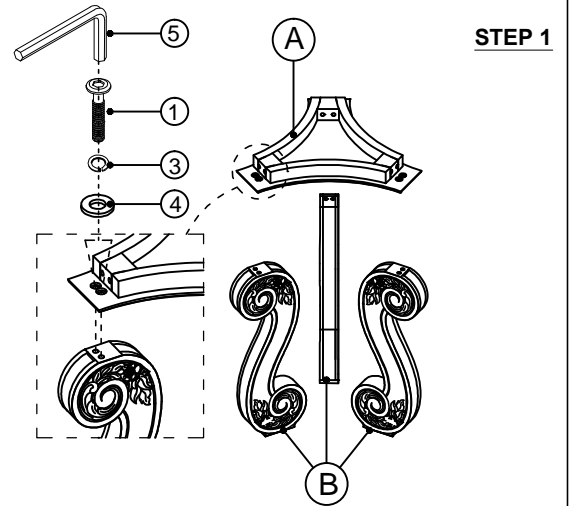

**STEP 2**

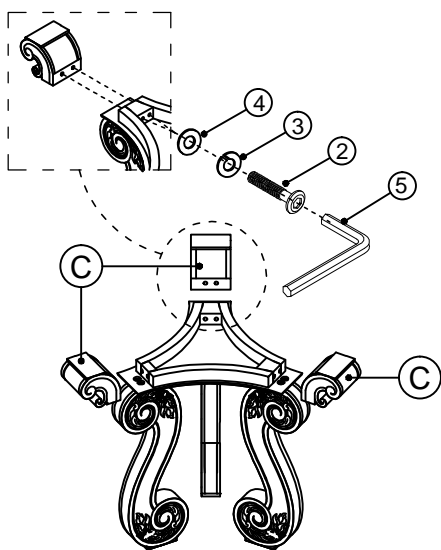

**STEP 3**

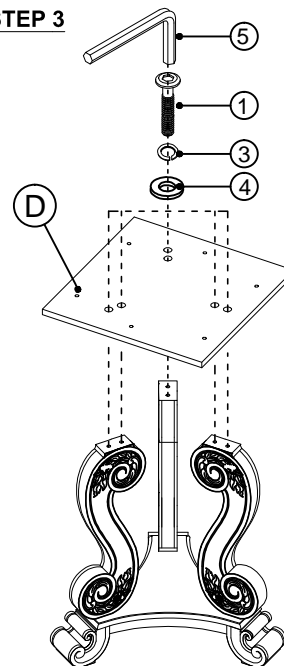

# ASSEMBLY INSTRUCTION

## MODEL: #61280/ 81 DINING TABLE

Thank you for purchasing this quality product. Be sure to check all packing material carefully for small parts which may have come loose inside the carton during shipment. Separate, identify and count all parts and metal hardware. Compare with parts list to be sure all parts are present. If any part(s) are missing or damaged, please contact your local furniture dealer. For efficient and speedy service, please indicate the model number and code letter of part(s) needed.

\*\*\* Do not fully tighten screws until fully assembled \*\*\*

### STEP 4

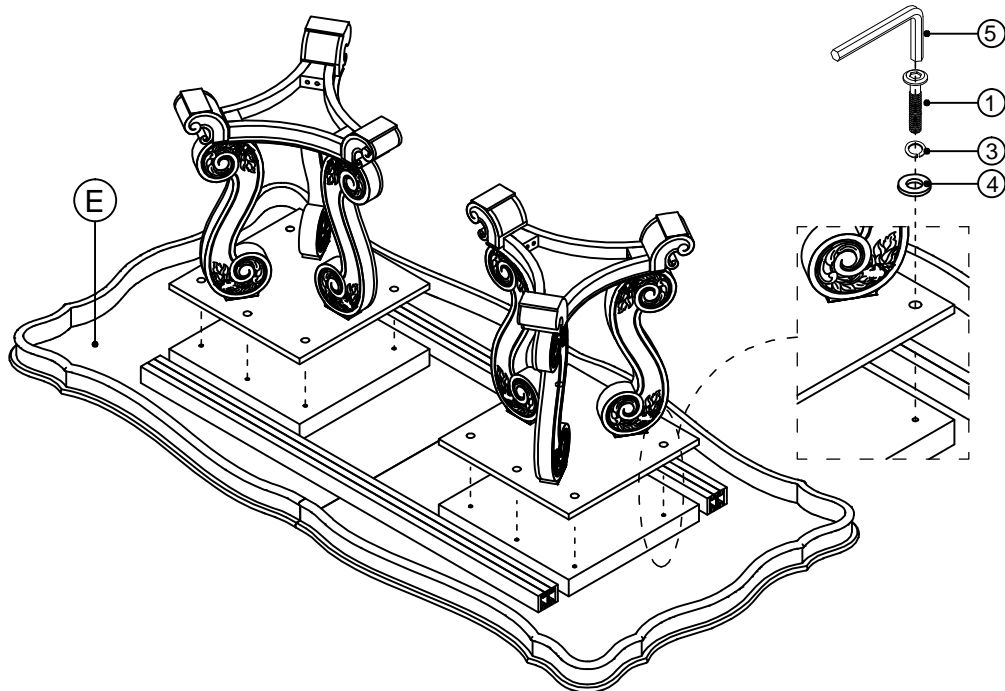

### STEP 5

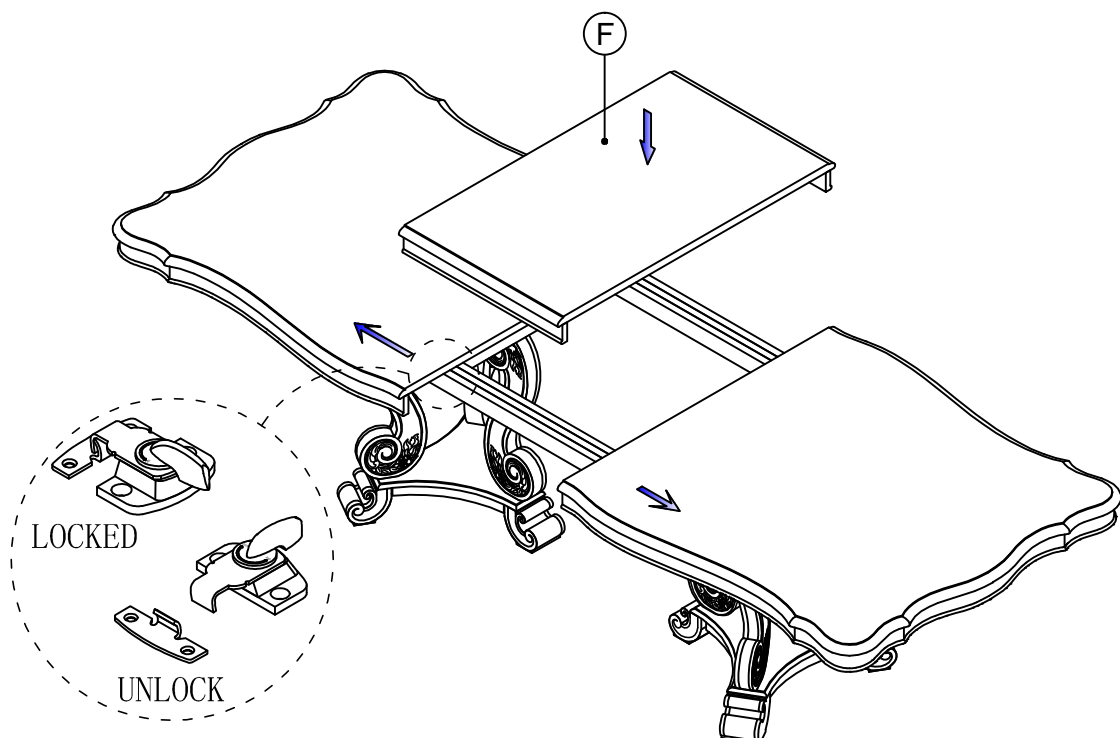

# ASSEMBLY INSTRUCTION

## MODEL: #61280/ 81 DINING TABLE

Thank you for purchasing this quality product. Be sure to check all packing material carefully for small parts which may have come loose inside the carton during shipment. Separate, identify and count all parts and metal hardware. Compare with parts list to be sure all parts are present. If any part(s) are missing or damaged, please contact your local furniture dealer. For efficient and speedy service, please indicate the model number and code letter of part(s) needed.

\*\*\* Do not fully tighten screws until fully assembled \*\*\*

### STEP 6

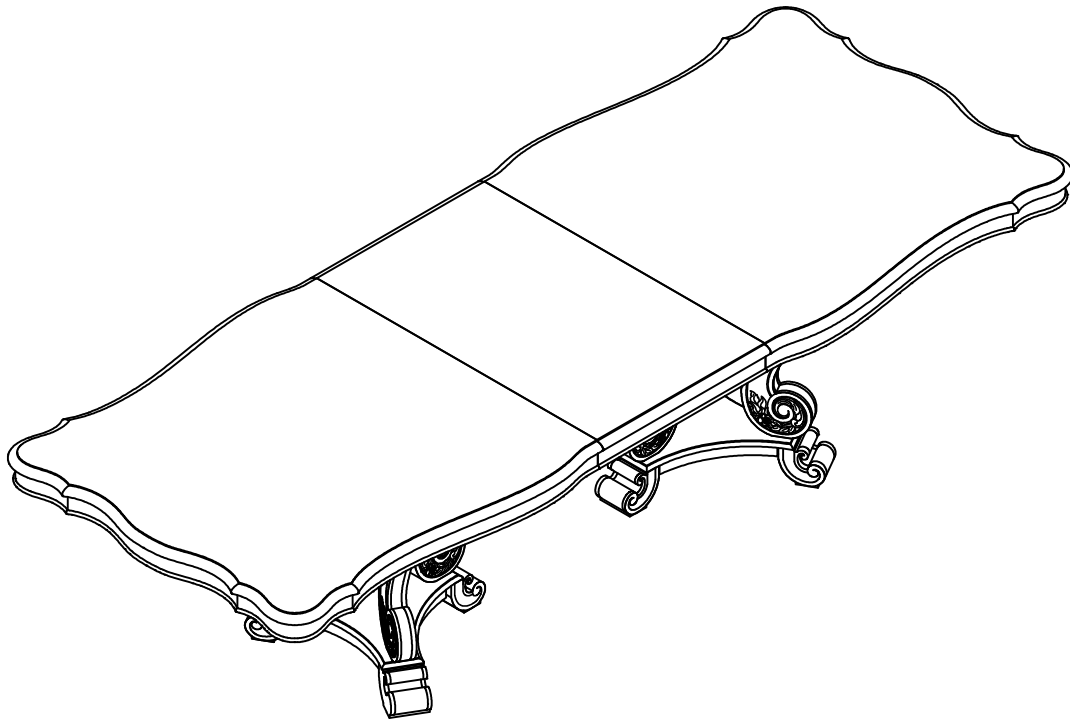

**COMPLETED**