















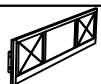

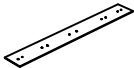
# **ASSEMBLY INSTRUCTION FOR ACME FURNITURE**

## **MODEL # 21596EK-HF(3A) /21597EK-R(3A)/21602Q-DRW(3A)**

Thank you for purchasing the quality product. Be sure to check all packing material carefully for small parts which may have come loose inside the carton during shipment. Separate, identify and count all parts and metal hardware. Compare with all parts list to be sure all parts are present. If any part(s) are missing or damaged, please contact your local furniture dealer. For efficient and speedy service, please indicate the model number and code letter of parts(s) needed.







\*\*\*Do not fully tighten screws until fully assembled\*\*\*

COMPONENT PARTS		
DESCRIPTION	PART NAME	Q'TY (PCS)
①	HEADBOARD 	1
②	FOOTBOARD 	1
③	HEADBOARD LEG(L&R) 	2
④	TRIANGLE SUPPORT PANEL 	2
⑤	DRAWER SUPPORT RAIL 2 	4
⑥	SUPPORT LEG 2 	1
⑦	SUPPORT LEG 3 	1
⑧	SIDE RAIL 	2
⑨	BED SLAT WITHOUT MARKING 	3
⑩	FOOTBOARD DRAWER FRAME 	1
⑪	CONCEALED PANEL 	6
⑫	HEADBOARD BACK SUPPORT 1 	1
⑬	DRAWER SUPPORT RAIL 	1
⑭	SUPPORT LEG 1 	5
⑮	HEADBOARD BACK SUPPORT 2 	1
⑯	BED SLAT WITH MARKING 	2
⑰	DRAWER 1 	4
⑱	DRAWER 2 	2

## HARDWARE REQUIRED(BOX OF HEADBOARD)



- (A)  FLATHEAD CHIPBOARD SCREW 5/32" x 1 2/8" - 8 PCS
- (B)  PANHEAD CHIPBOARD SCREW 4/32"x 13/16"- 8 PCS
- (C)  BOLT 1/4" x 1 3/8" - 4 PCS
- (D)  BOLT 1/4" x 2" - 2 PCS
- (E)  SPRING WASHER 1/4"- 4 PCS
- (F)  FLAT WASHER 1/4"- 4 PCS
- (G)  ALLEN KEY 4 5/16" - 1 PC

## HARDWARE REQUIRED(BOX OF SIDE RAIL)

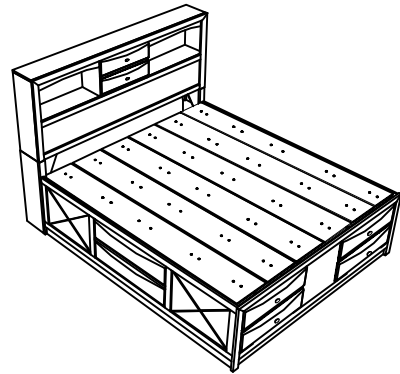
- (H)  FLATHEAD CHIPBOARD SCREW 5/32" x 1 2/8"- 16 PCS
- (I)  PAN HEADCHIPBOARD SCREW 4/32"x 13/16"- 32 PCS
- (J)  1/4" x 1 3/8" - 15 PCS
- (K)  BOLT 1/4" x 2" - 6 PCS
- (L)  SPRING WASHER 1/4"- 15 PCS
- (M)  FLAT WASHER 1/4"- 15 PCS
- (N)  Z-BRACKET - 1 PC
- (O)  ALLEN KEY 4 5/16" - 1 PC



## HARDWARE REQUIRED(DRAWER)

- (P)  HANDLE"- 8 PCS
- (Q)  TRUS HEAD M.SCREW 5/32" x 1 7/8"- 4 PCS
- (R)  TRUS HEAD M.SCREW 5/32" x 2"- 4 PCS

# How to assemble:

Step 1:

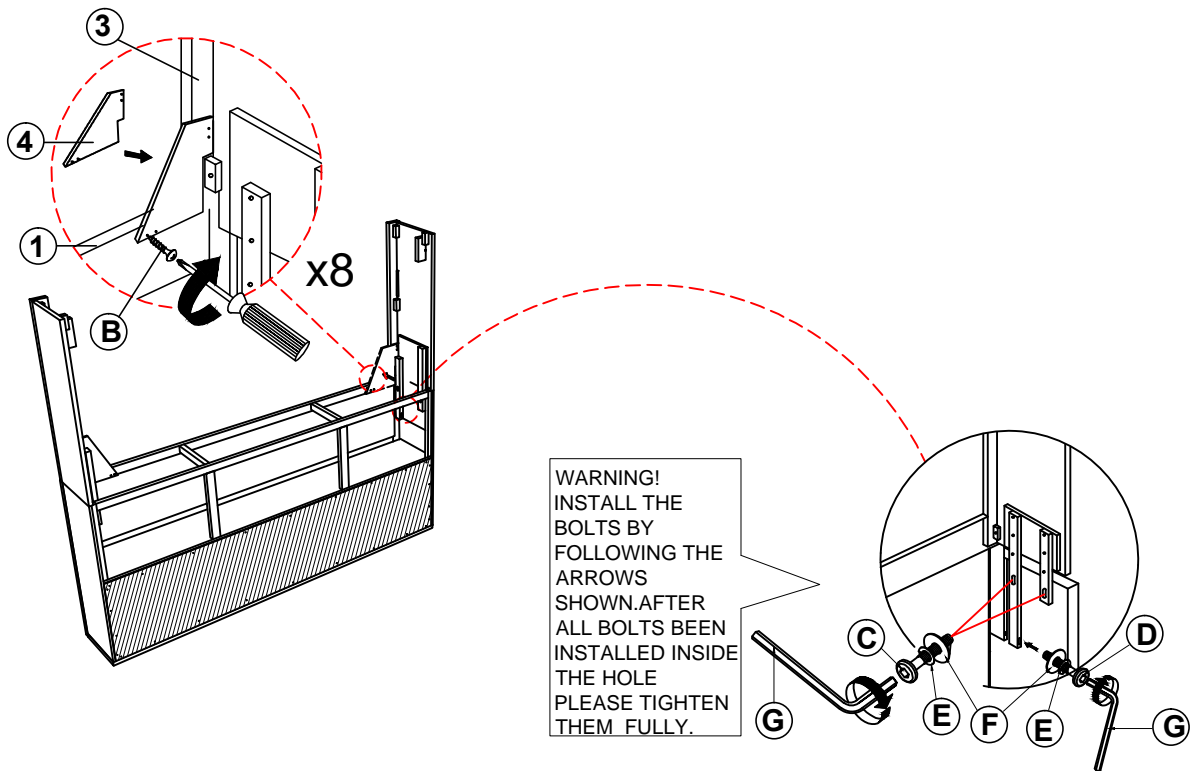

Step 2:

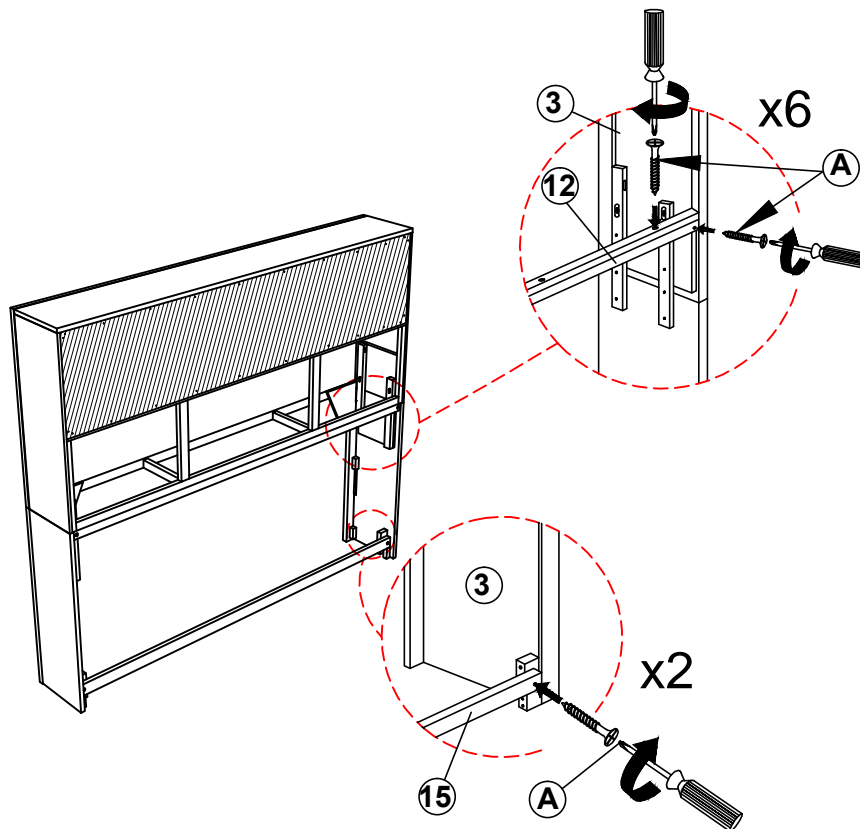

# How to assemble:

Step 3:

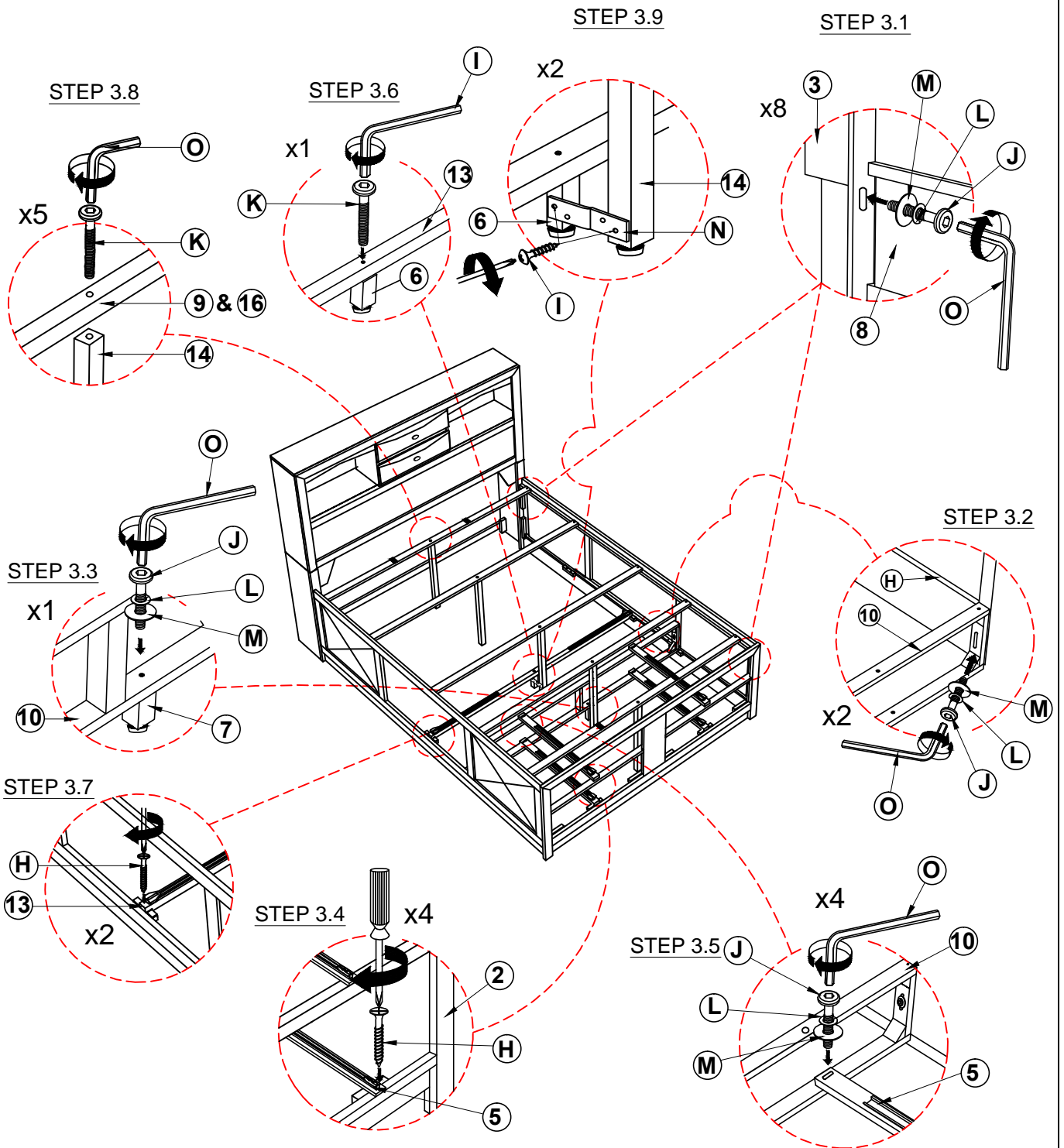

# How to assemble:

Step 4:

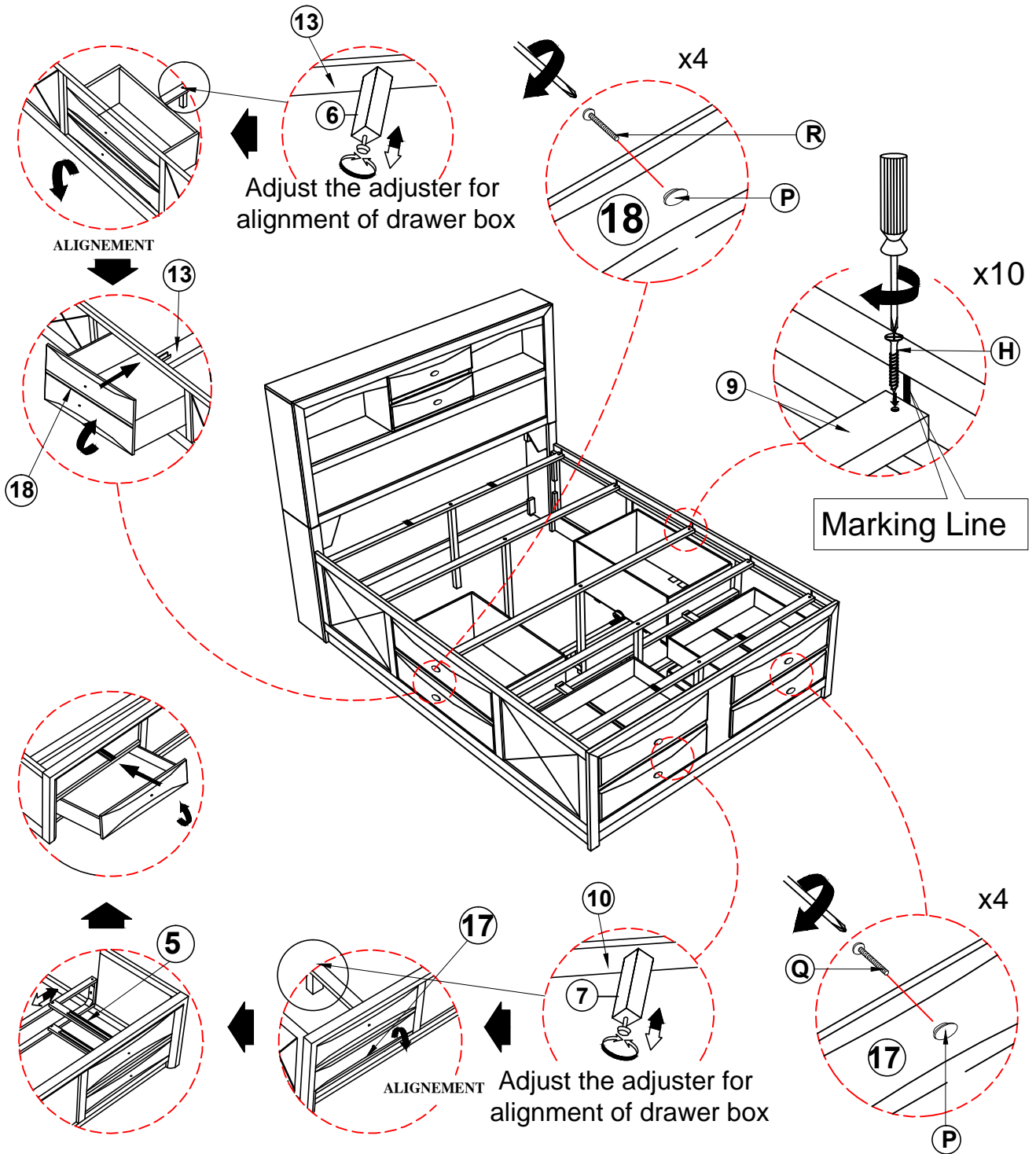

# How to assemble:

Step 5:

