









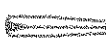

# ASSEMBLY INSTRUCTION

ITEM NO: 10033B/16774B/16776B

\* DO NOT TIGHTEN SCREWS UNTIL COMPLETELY ASSEMBLED

NO	DESCRIPTION	Q'TY
A	 CHAIR BACK	1 PC
B	 SEAT	1 PC
C	 FRONT LEG	2PCS
D	 LOCK WASHER 5/16"	11PCS
E	 FLAT WASHER 5/16"	11PCS
F	 BOLT 1/4" DIA 5/16"X3-1/2"	4PCS
G	 BOLT 1/4" DIA 5/16"X 1-3/4"	3PCS
H	 BOLT 1/4" DIA 5/16"X2-1/4"	4PCS
I	 ALLEN WRENCH 5mm	1 PC
J	 DOWEL 10X35mm	1 PC

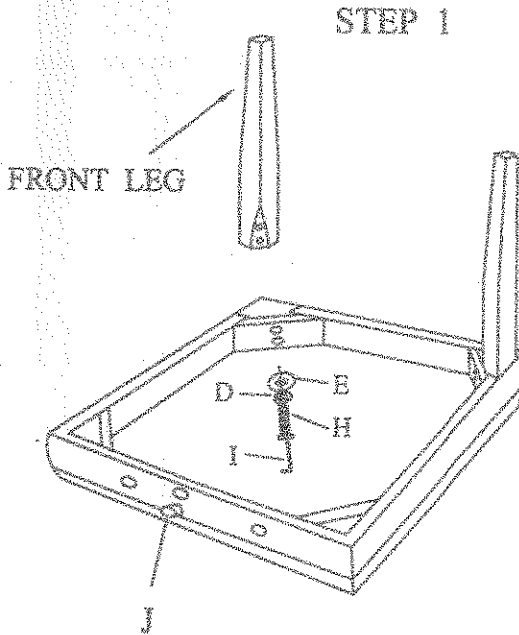

STEP 3

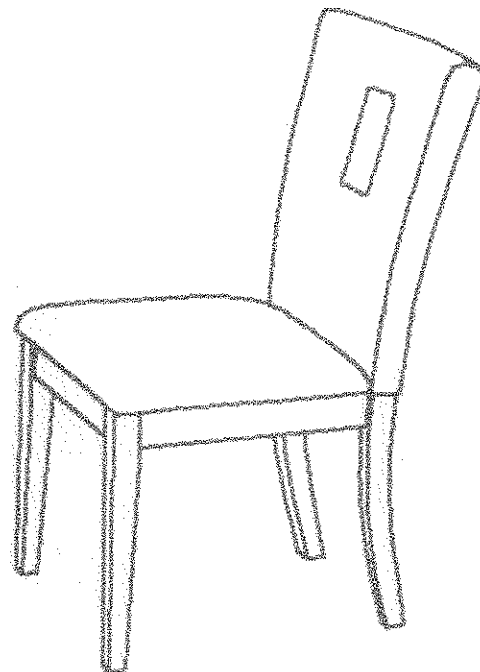

STEP 2

