

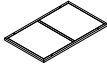

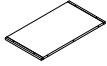







ASSEMBLY INSTRUCTION FOR ACME FURNITURE



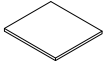
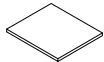









MODEL# 30540 Butterfly Wardrobe

Thank you for purchasing this quality product. Be sure to check all packing materials carefully for small parts which may have come loose inside the carton during shipment. Separate, identify, and count all parts and metal hardware. Compare with parts list to be sure all parts are present. If any part(s) are missing or damaged, please contact your local furniture dealer. For efficient and speedy service, please indicate the model number and code letter of the part(s) needed.

*** Do not fully tighten screws until fully assembled ***

COMPONENT PARTS		
DECERPTION	PART NAME	Q'TY(PCS)
①	Top Board 	1pc
②	Bottom Board 	1pc
③	Back Plate 	1pc
④	Doors 	1pc
⑤	Left Plate 	1pc
⑥	Middle Plate 	1pc
⑦	Right Plate 	1pc
⑧	Left Shelf 	4pcs
⑨	Right Shelf 	1pc

⑩	Support Angle Iron		1pc
⑪	Hanger Tube		1pc
⑫	Foot		4pcs

<u>HARDWARE REQUIRED:</u>	
(A) 	Bolt 3/16"x3/8" - 46pcs
(B) 	Bolt 1/4"x1-3/8" - 4pcs
(C) 	M4x8 - 6pcs
(D) 	Washer - 4pcs
(E) 	Nut M4 - 2pcs
(F) 	Screw M4 - 1pc
(G) 	Metal Plate - 2pcs
(H) 	Anchor - 1pc
(I) 	Girding - 1pc
(J) 	Allen Wrench M4 - 1pc
(K) 	Adjust Foot - 4pcs
(L) 	LEFT - 1pc
(M) 	RIGHT - 1pc

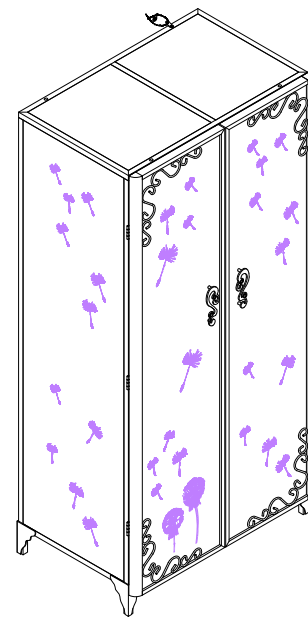

Attention:

***Mattresses not included.

***Some number parts listed on the instruction sheet may not be in parts bag as they may already be assemble.
Carefully check parts and packing materials prior to ordering replacements.

How to Assemble:

STEP 1.

Exploded View

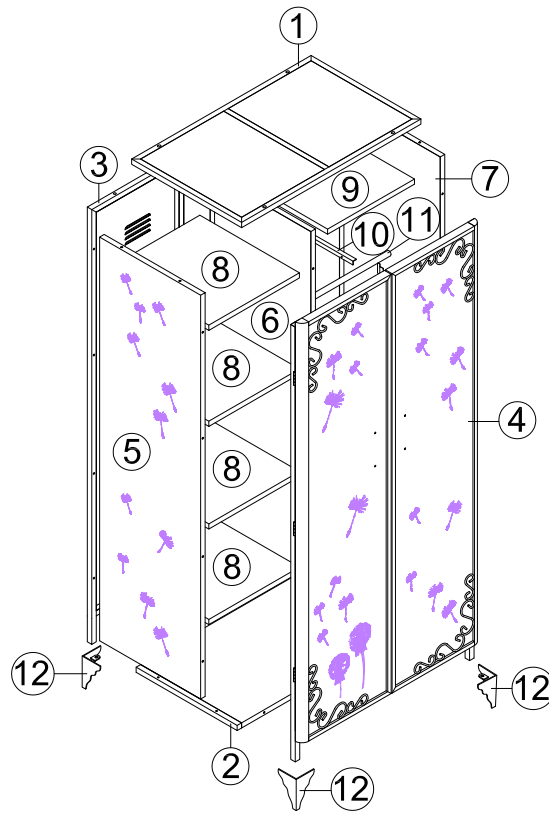

STEP 2.

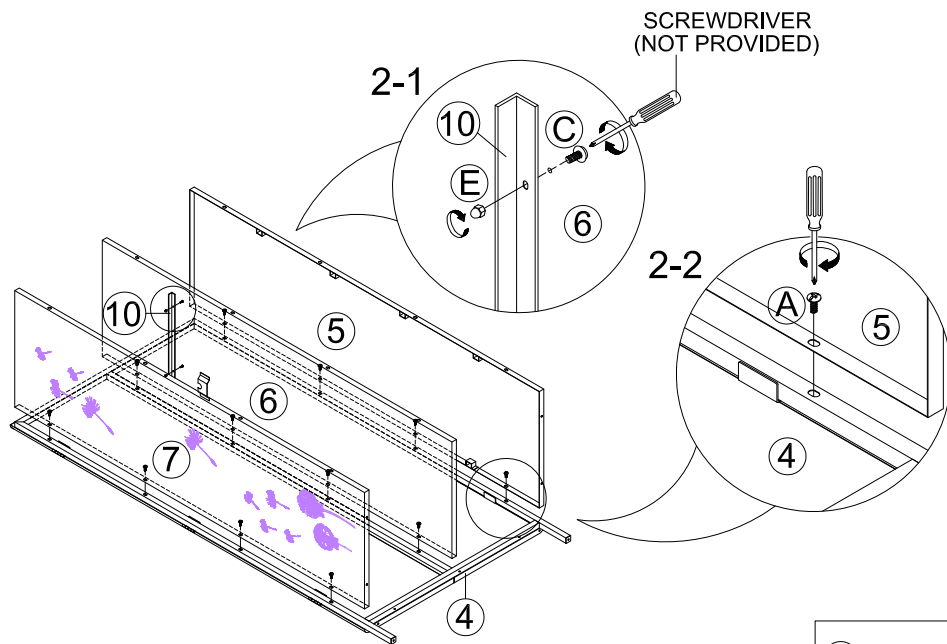

(A)		12pcs
(C)		2pcs
(E)		2pcs

How to Assemble:

STEP 3.

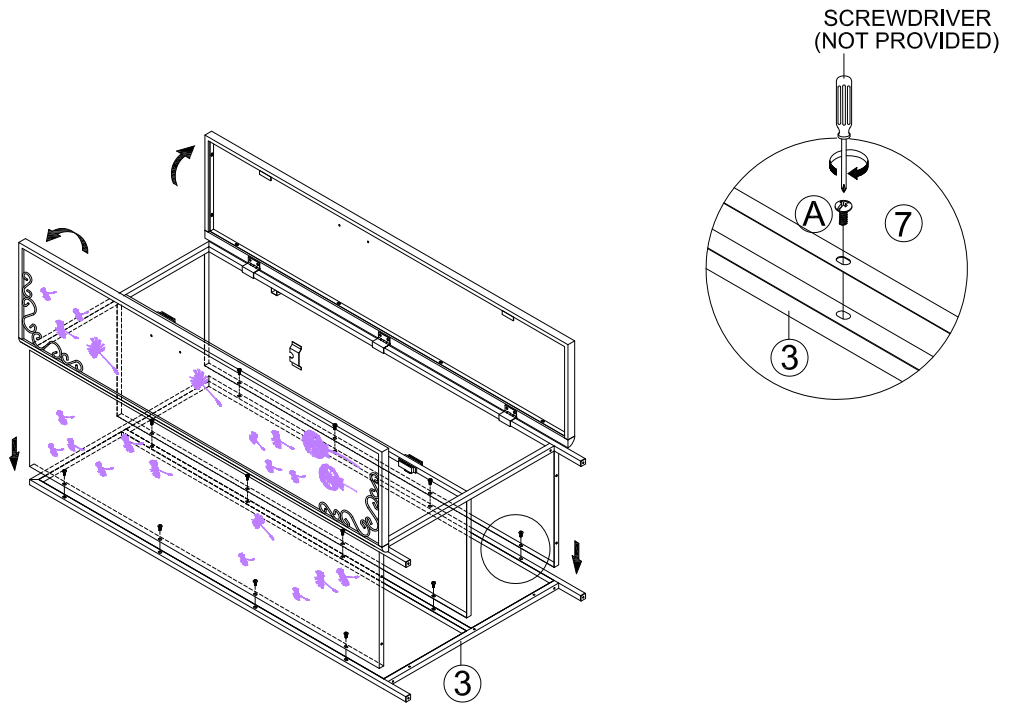

A		12pcs
----------	---	-------

STEP 4.

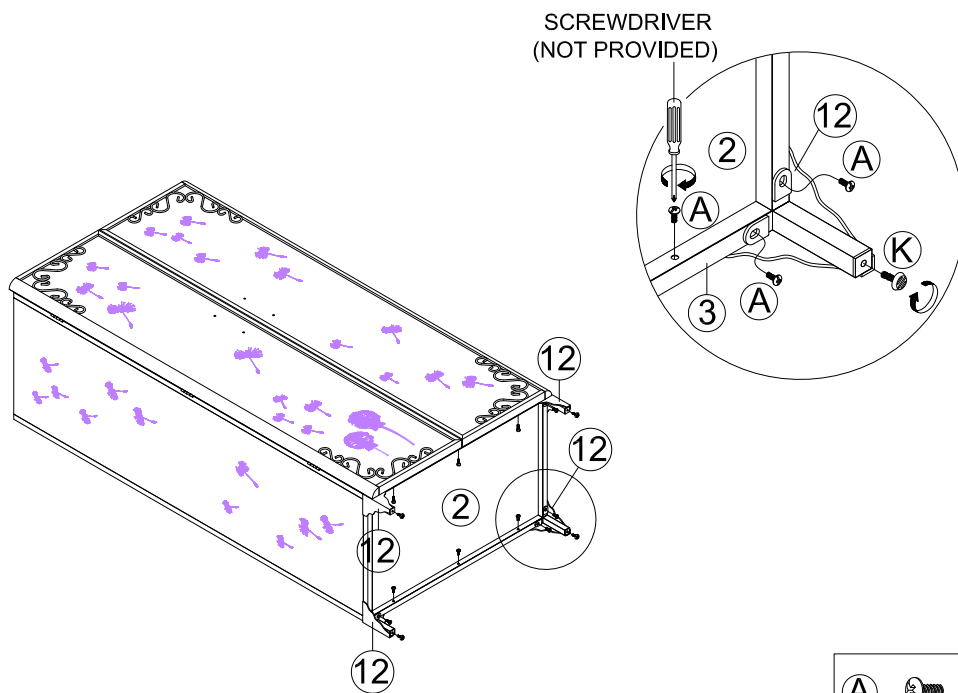

A		14pcs
----------	---	-------

K		4pcs
----------	---	------

How to Assemble:

STEP 5.

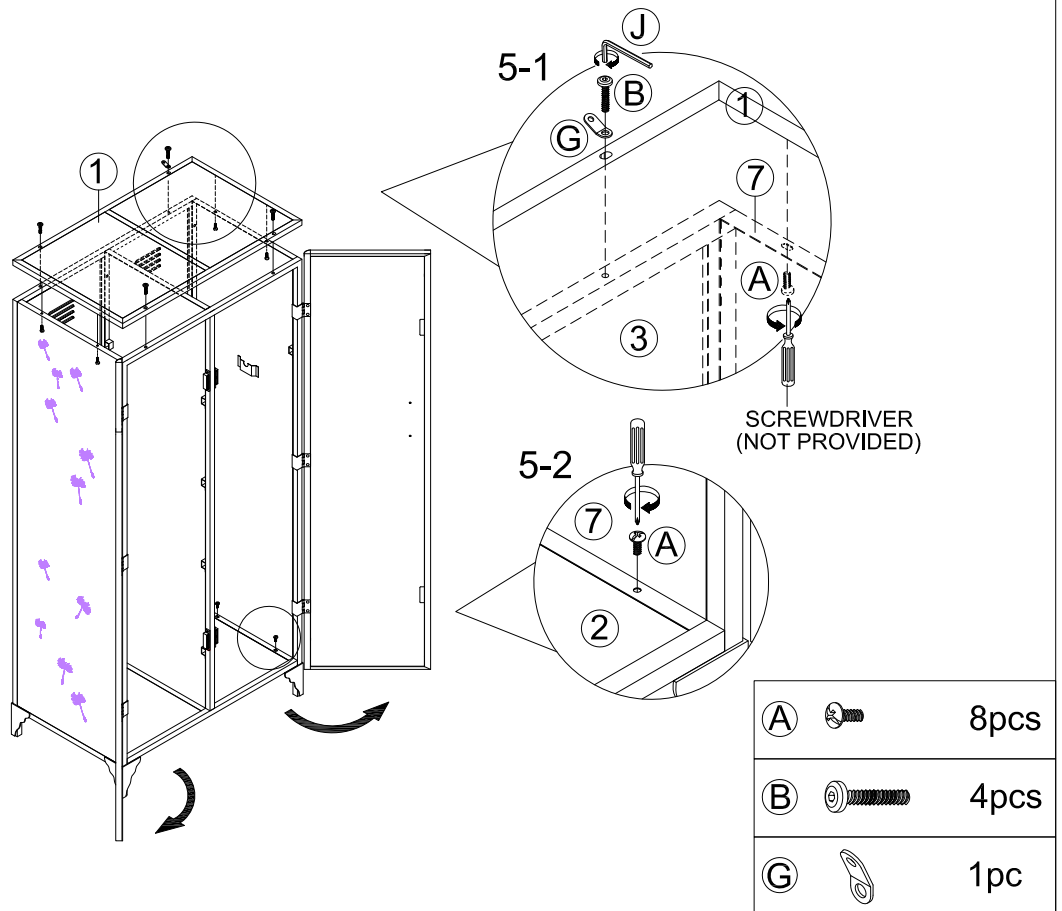



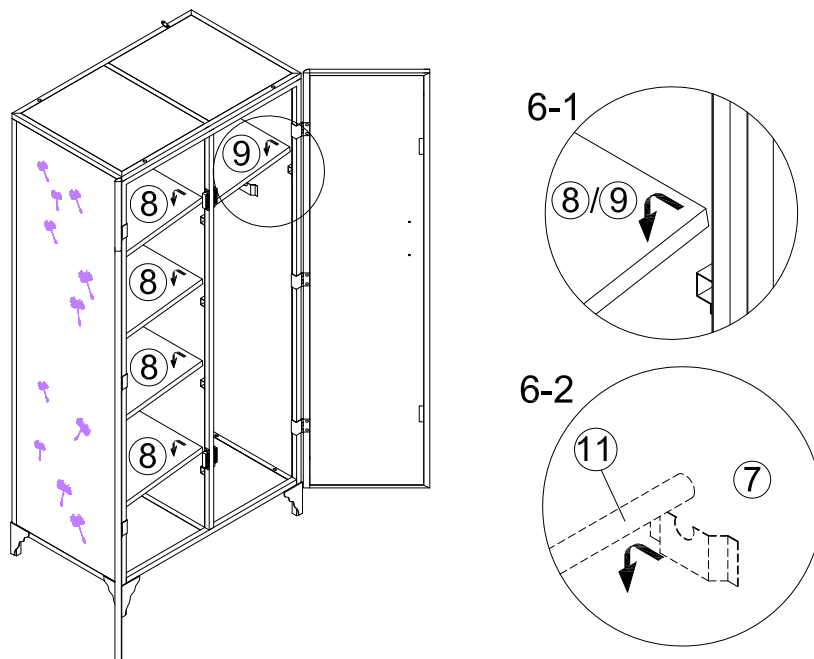

STEP 6.

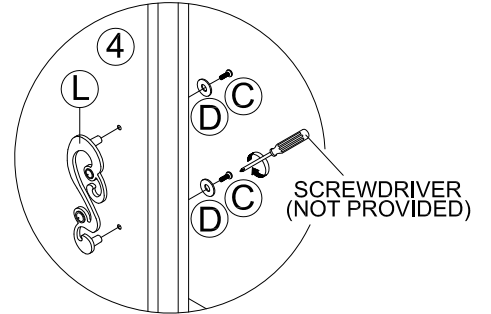
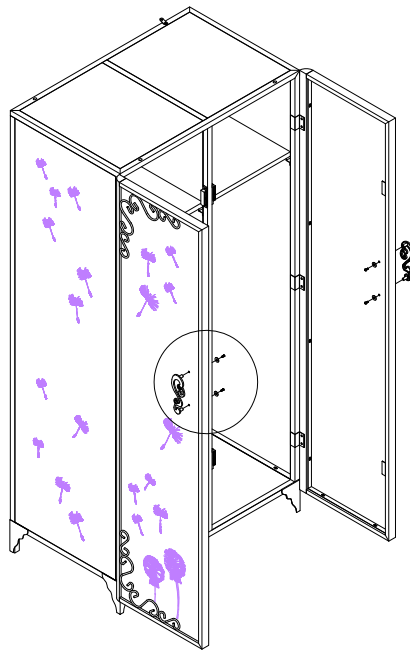

How to Assemble:

STEP 7.



C		4pcs
D		4pcs
L		1pc
M		1pc

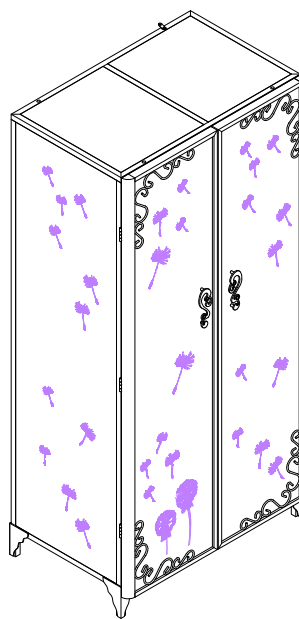

STEP 8.

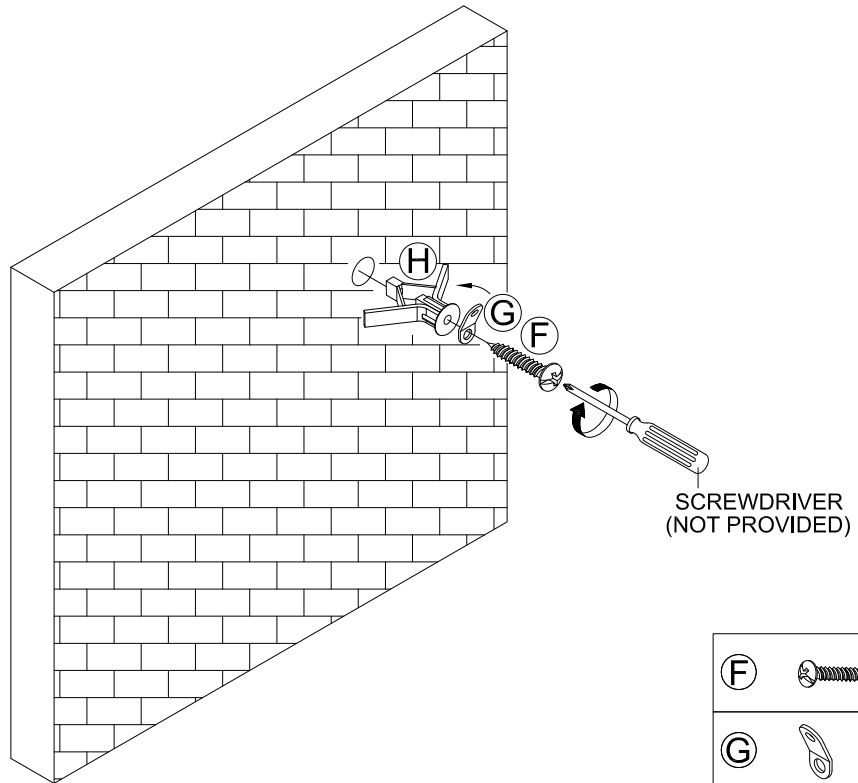

How to Assemble:

STEP 9.



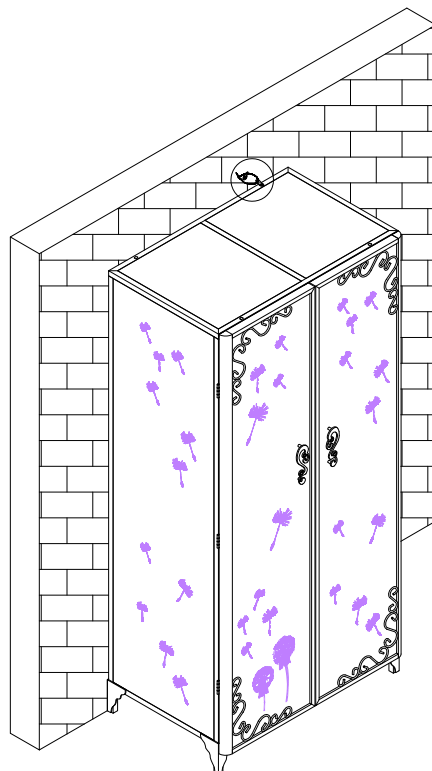

(F)		1pc
(G)		1pc
(H)		1pc

STEP 10.

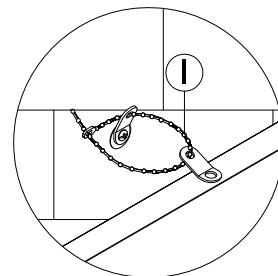

To Prevent Tip over
Product Must Be
Attached To Wall



(I)		1pc
-----	---	-----