

Model: #20650Q-HF/20651Q-R/20890Q-HF/20891Q-R/20900Q-HF/20901Q-R/20880Q-HF/20881Q-R (#213066-5/0)

#20647EK-HF/20648EK-R/20887EK-HF/20888EK-R/20897EK-HF/20898EK-R/20877EK-HF/20878EK-R (#213066-6/6)

#20644CK-HF/20645CK-R (#213066-6/0)









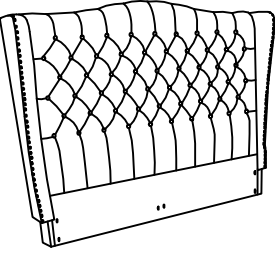
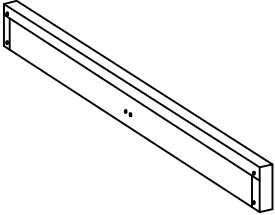

#20655F-HF/20656F-R (#213066-4/6)

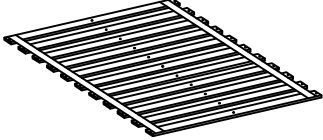
ASSEMBLY INSTRUCTIONS

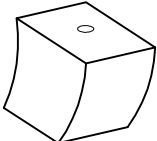
Thank you for purchasing this quality product. Be sure to check all packing materials carefully for small parts which may have come loose inside the carton during shipment. Identify and count all parts and compare with the parts list below.

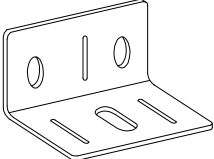
**Assemble product on a flat, soft surface such as a carpet or cloth to prevent scratching the finish. Read all instruction and study the drawings carefully before starting the assembly process.

Parts list:

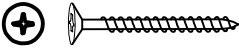
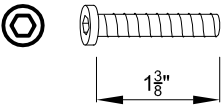
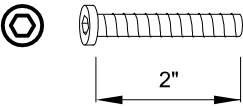
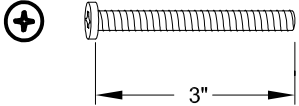
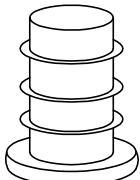
A HEADBOARD (1 PC) 	B FOOTBOARD (1 PC) 	C RAILS (2 PCS) 	D SLAT (1 PC) 
E CENTRE SUPPORT (1 PC) 	F WOOD LEGS (4 PCS) 	G WOOD LEGS (3 PCS) 	H METAL PLATES (10PCS) 
I FLAT WASHERS (30 PCS+1PC SPARE) 	J LOCK WASHERS (30 PCS+1PC SPARE) 	K ALLEN KEY (1 PC) 	L WOOD SCREWS (33 PCS+1PC SPARE) 
M BOLTS (28 PCS+1PC SPARE) 	N BOLTS (2 PCS) 	O BOLTS (4 PCS) 	P PLASTIC CAPS (4 PCS) 

How to assemble:

STEP 1:

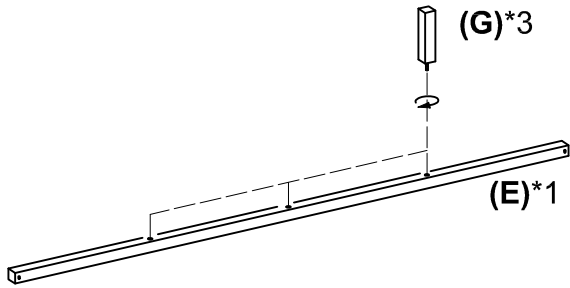

STEP 2: Assemble the metal plates with two rails, Each rail need (H)*4, (I)*8, (J)*8, (M)*8.

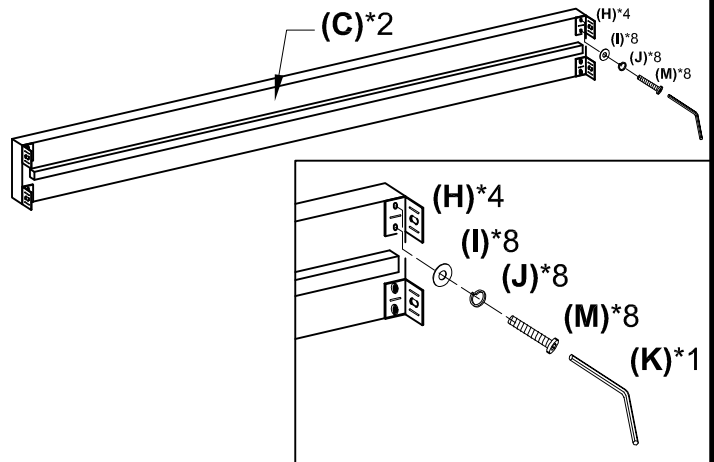

STEP 3:

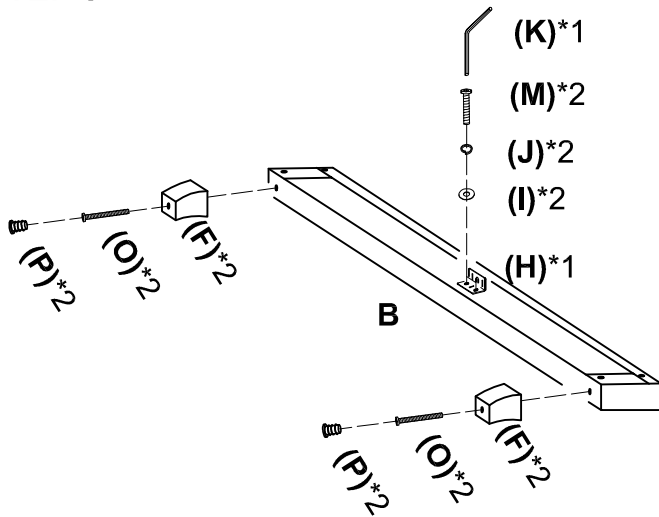

STEP 4:

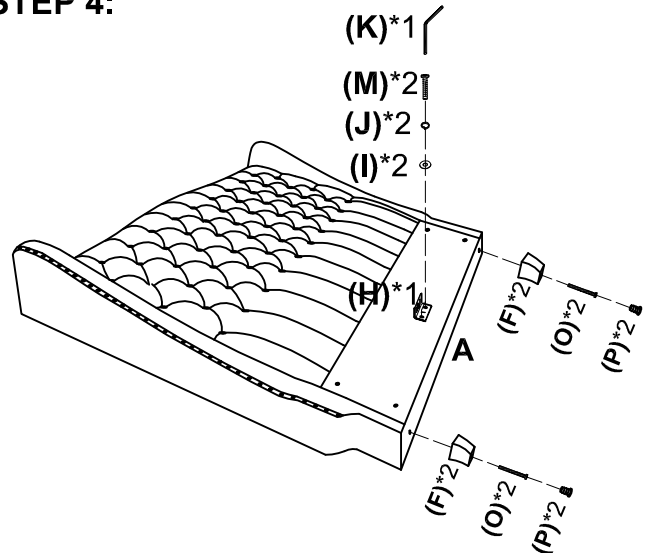

STEP 5: Assemble the two rails with headboard and footboard, total need (I)*8, (J)*8, (M)*8. Assemble the centre support (E), total need (I)*2, (J)*2, (N)*2.

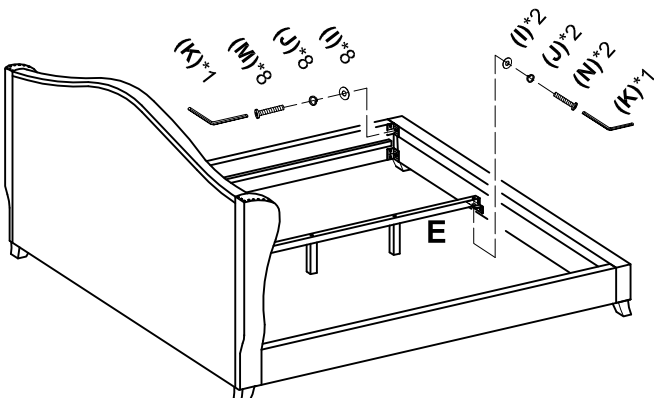

STEP 6: Assemble the Slat (D) with two rails and centre support, total need (L)*33.

