









ASSEMBLY INSTRUCTION FOR ACME FURNITURE

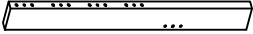





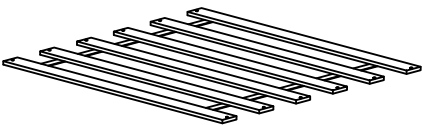



MODEL#21528T-W

Thank you for purchasing the quality product. Be sure to check all packing material carefully for small part which may have come loose inside the carton during shipment. Separate, identify and count all parts and metal hardware. Compare with all parts list to be sure all parts are present. If any part(s) are missing or damaged, please contact your local furniture dealer. For efficient and speedy service, please indicate the model number and code letter of part(s) needed.

***** Do not fully tighten screws until fully assembled *****

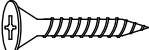
COMPONENT PARTS			
DESCRIPTION	PART NAME		QTY (PCS)
①	HEADBOARD PANEL		3
②	HEADBOARD POST (LEFT)		1
③	HEADBOARD POST (RIGHT)		1
④	FOOTBOARD PANEL		1
⑤	FOOTBOARD POST (LEFT)		1
⑥	FOOTBOARD POST (RIGHT)		1
⑦	SIDE RAIL (LEFT)		2
⑧	SIDE RAIL (RIGHT)		2
⑨	SIDE RAIL CENTER LEG		2
⑩	SLATS		2 SET

HARDWARE REQUIRED

(A)		JCBC M6 x 100mm	8	PCS
(B)		JCBC M6 x 70mm	8	PCS
(C)		JCBC M6 x 30mm	8	PCS
(D)		BARREL NUT M6 x 15mm	16	PCS
(E)		JCN M6 x 15mm	8	PCS
(F)		WOOD DOWEL M10 x 40mm	4	PCS
(G)		CSK SCREW M4 x 25mm	24	PCS
(H)		ALLEN KEY M4	2	PCS
(I)		WOOD DOWEL M8 x 30mm	16	PCS
(J)		WOOD DOWEL M10 x 25mm	4	PCS
(K)		WOOD BUTTON	16	PCS

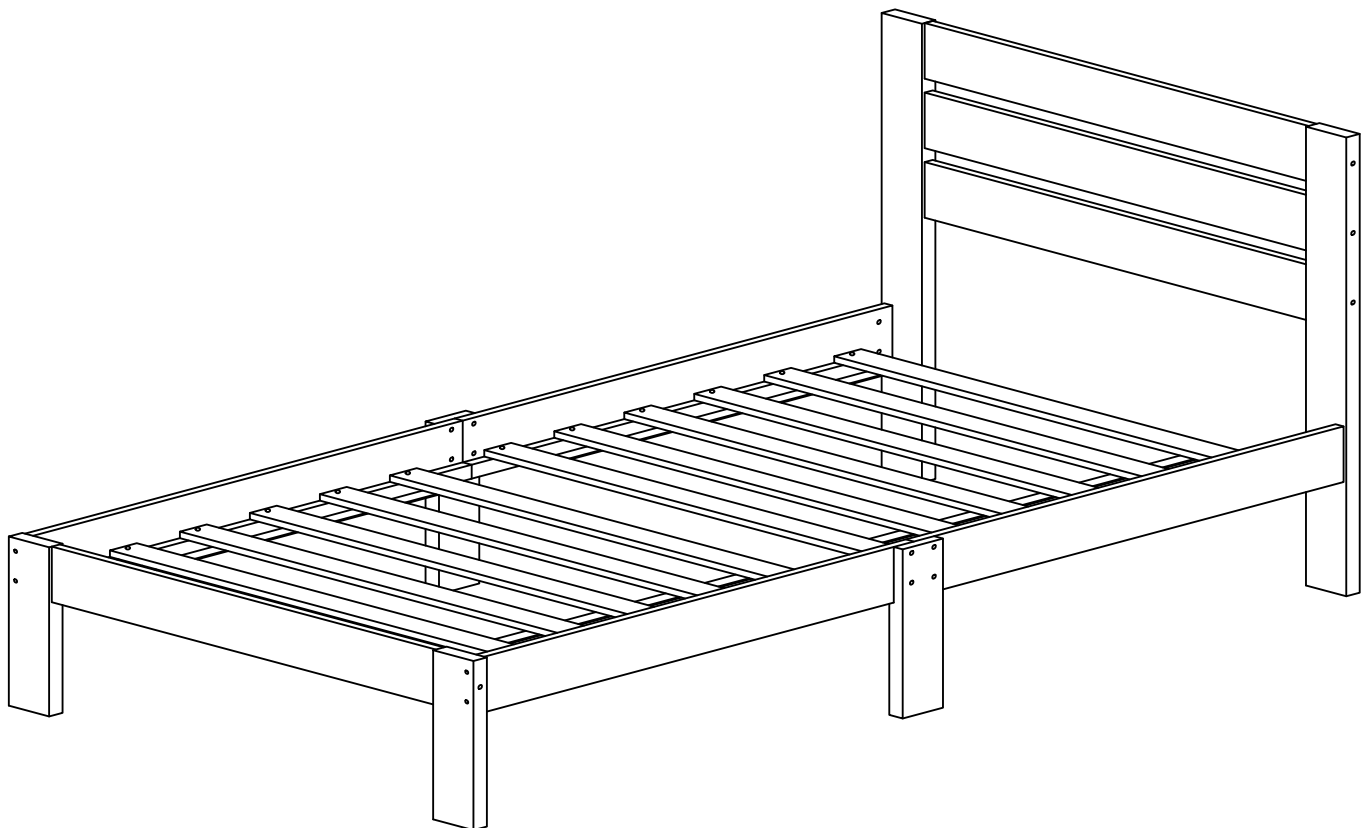

Attention

*** Some number parts listed on the instruction sheet may not be in parts bag as they may already be assembled.
Carefully check parts and packing materials prior to ordering replacements.

STEP 1 Required Fittings : A x 6 pcs D x 6 pcs I x 12 pcs K x 6 pcs

1. Headboard Assembly.

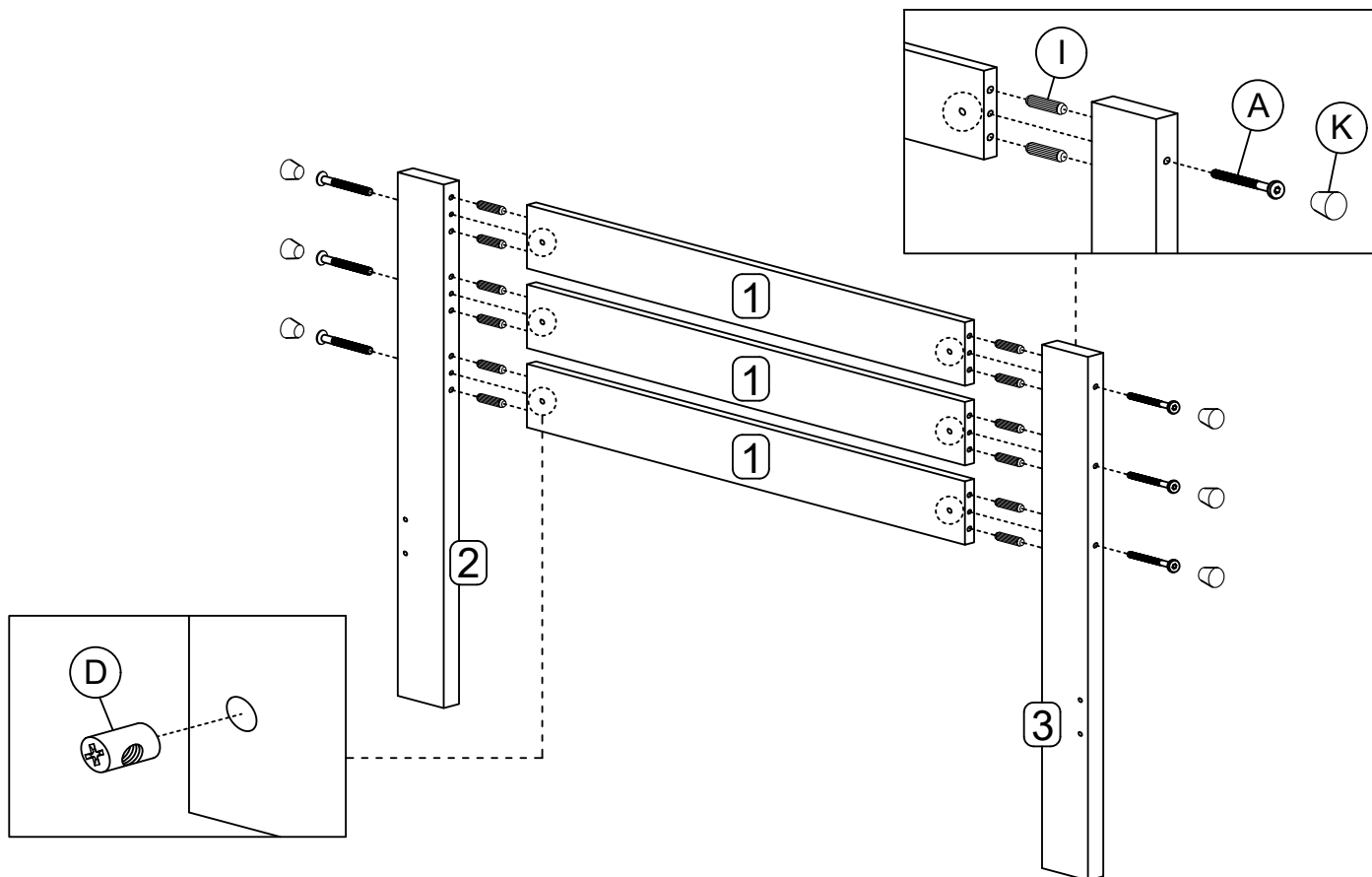

STEP 2 Required Fittings : A x 2 pcs D x 2 pcs I x 4 pcs K x 2 pcs

1. Footboard Assembly.

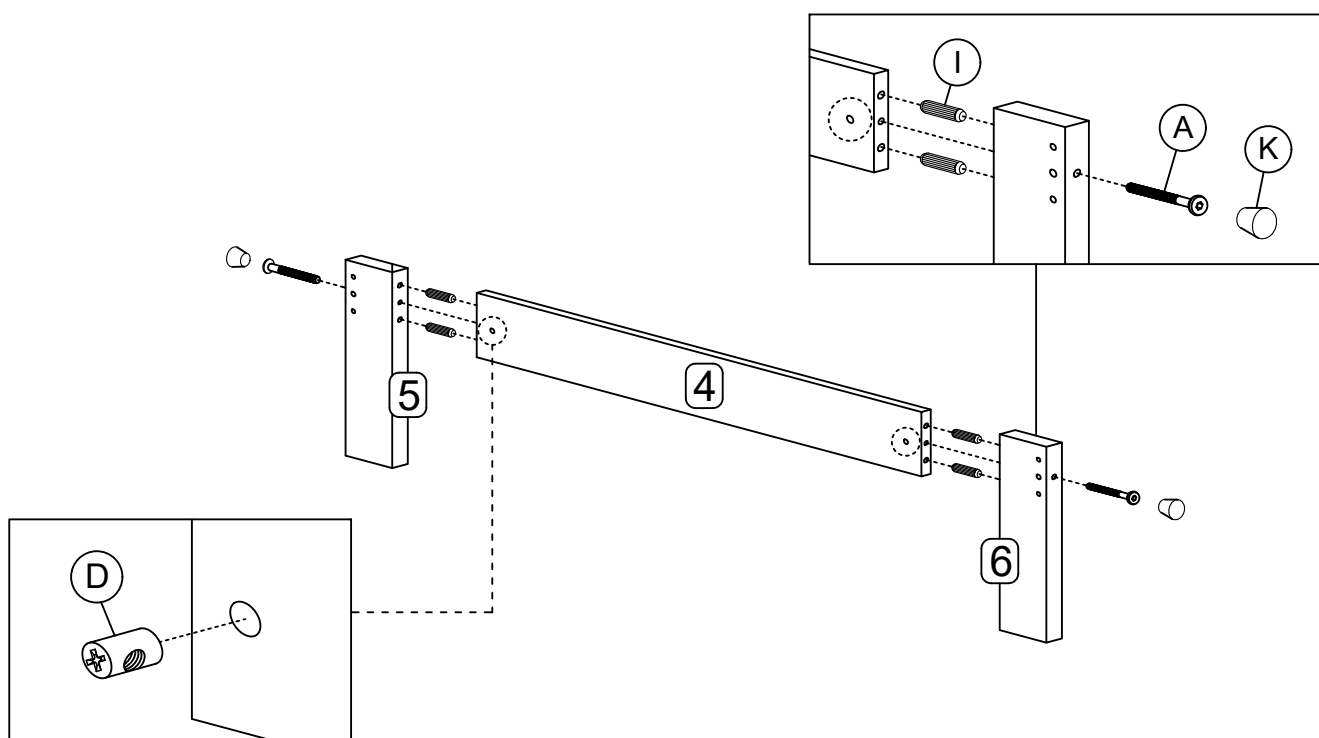

STEP 3 Required Fittings : C x 4 pcs J x 2 pcs E x 4 pcs H x 2 pcs
1. Attach Side Rail (Left) With Side Rail Center Leg.

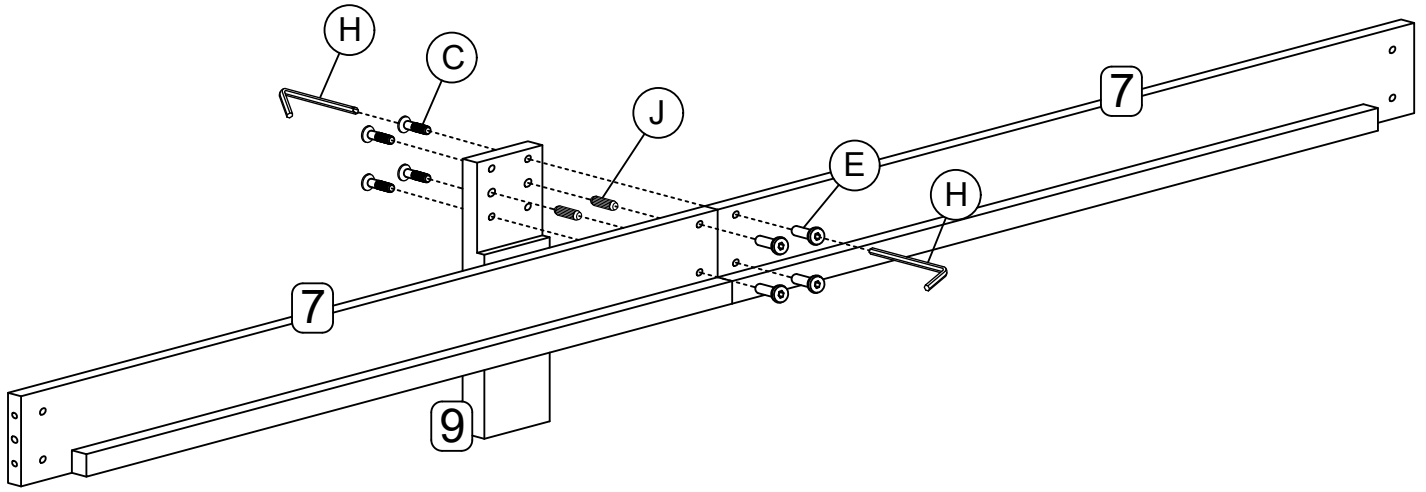

STEP 4 Required Fittings : E x 4 pcs J x 2 pcs C x 4 pcs H x 2 pcs
1. Attach Side Rail (Right) With Side Rail Center Leg.

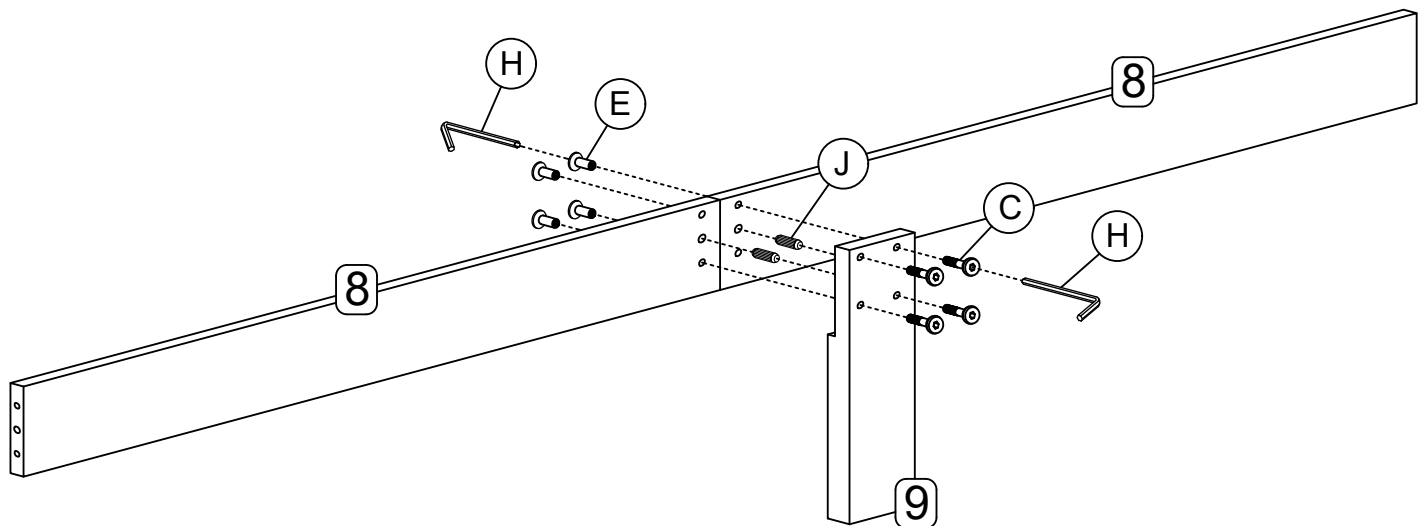

STEP 5 Required Fittings : D x 8 pcs B x 8 pcs F x 4 pcs K x 8 pcs
Attach Head & Footboard With Side Rails

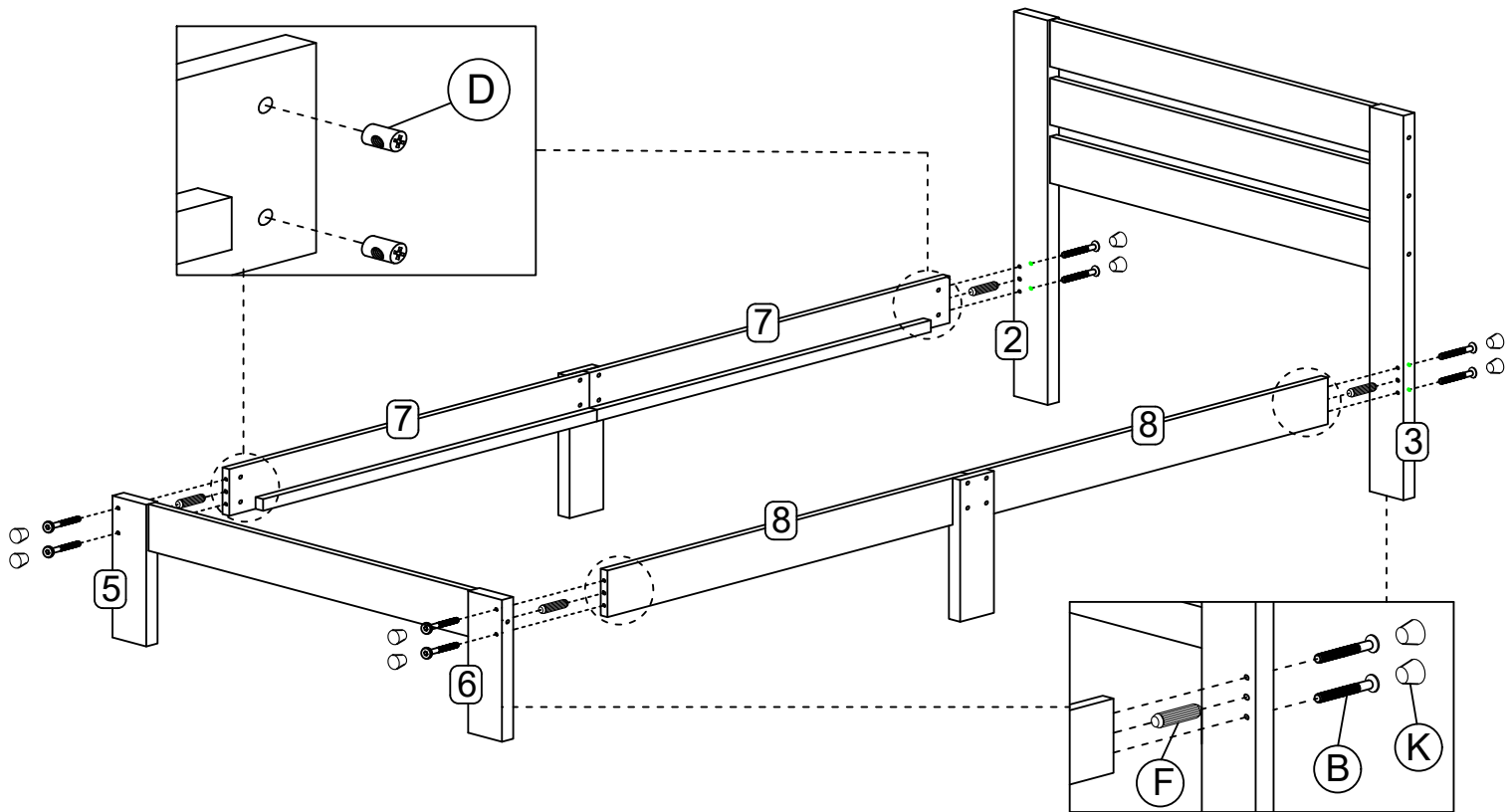

STEP 6 Required Fittings : G x 24 pcs
Attach Slats To Bed Frame.

- Useful Tips :
1. Carefully place those slats onto the bed frame to prevent scratches.
 2. Drill in the first and last piece of slats in order to hold the position before drilling the rest of the slats.

