



# ASSEMBLY INSTRUCTION

MODEL NO: JORDYN - WHITE / GREY - MR





DESCRIPTION: MIRROR

Thank you for purchasing this quality product. Be sure to check all packing material carefully for small parts that may have come loose inside the carton during shipment.

## PART LIST :

ITEM	DRAWING	DESCRIPTION	QTY
A		MIRROR	1
B		MIRROR SUPPORT	1
C		MIRROR SUPPORT	1

## HARDWARE LIST :

ITEM	DRAWING	DESCRIPTION	QTY
D		JCB SCREW ( M6 x 35mm )	8
E		SPRING WASHER ( M8 )	8
F		FLAT WASHER ( M8 x 18mm )	8
G		ALLEN KEY ( M4 x 65mm )	1

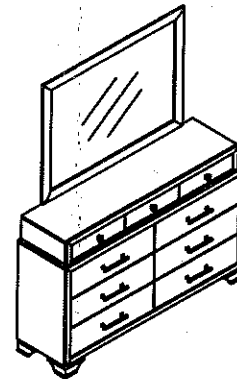

COMPLETED MIRROR

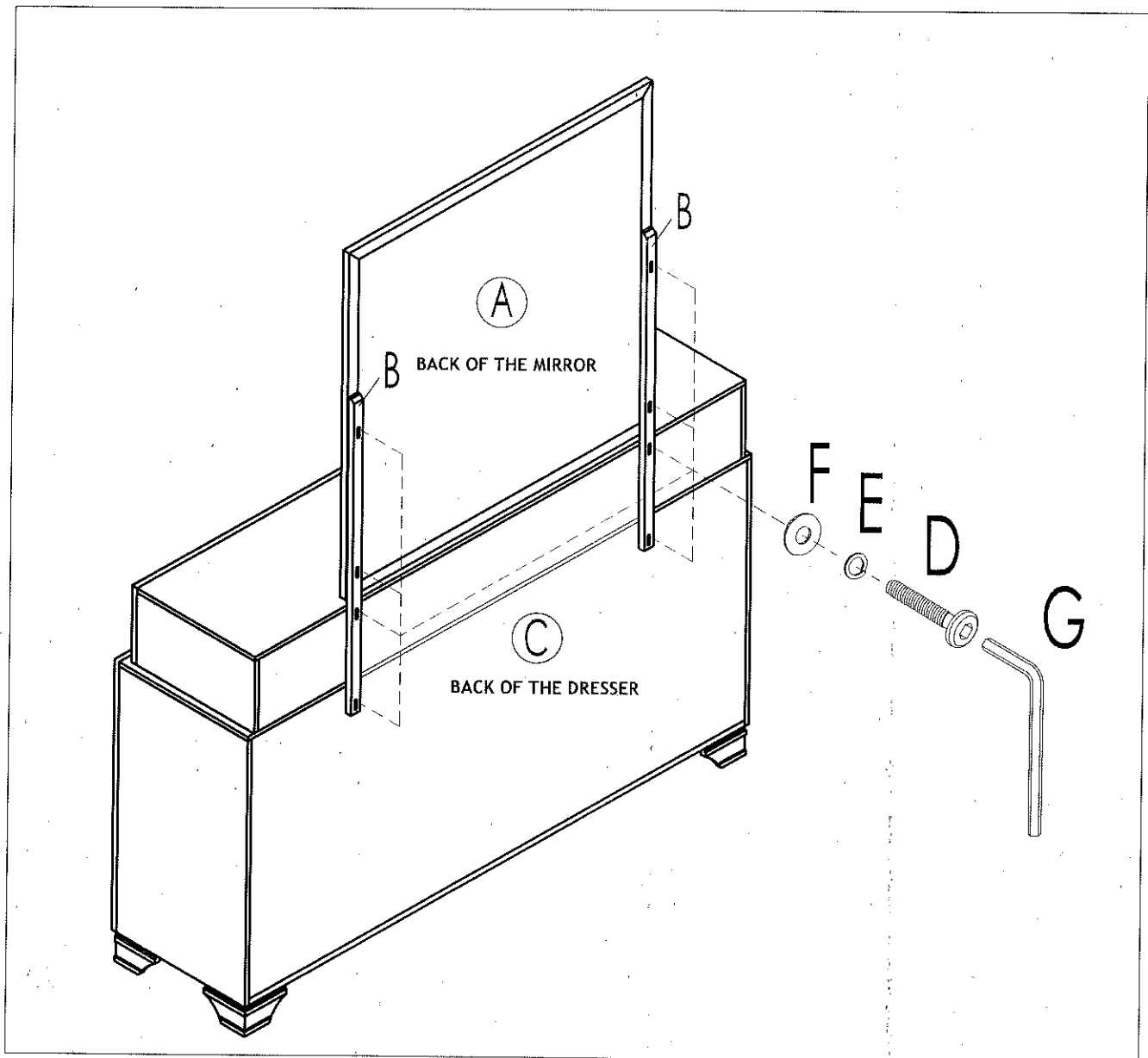

NOTE : MUST TIGHTEN SCREWS PERIODICALLY. WITH USE SCREW MAY BECOME LOOSE. CHECK TIGHTNESS OF ALL SCREWS EVERY 6-8 WEEKS.

### CLEANING INSTRUCTION :

AFTER ASSEMBLE, CLEAN & POLISH THE COMPLETED PARTS IF NECESSARY WITH SOFT CLOTH AND INDUSTRIAL RECOGNIZED FURNITURE POLISH.

MADE IN MALAYSIA