





# MODEL RTA-3528



## ASSEMBLY INSTRUCTIONS

REV.5-HGO-A9297-0326

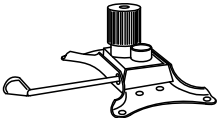

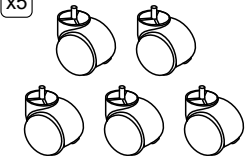
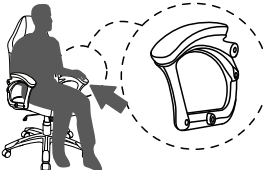
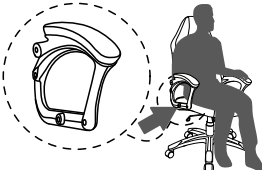
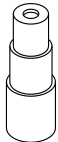



Thank you for purchasing our product!

MAIN PARTS LIST	
<b>A</b> Backrest	<b>B</b> Seat
	
<b>C</b> Nylon star base	<b>D</b> Mechanism
	
<b>E</b> Lift cylinder	<b>F</b> Casters
	
<b>G-L</b> Left armrest	<b>G-R</b> Right armrest
	
<b>H</b> Covers for lift cylinder	
	

HARDWARE LIST			
Part #	QTY	SIZE/Description	Item
I	4	M8x20	 mm 10 20 30 40 50 60
J	8	M6x25	 mm 10 20 30 40 50 60
K	8	Caps	

INCLUDED TOOLS	
Allen Wrench	

	For support with assembly questions & replacement parts please email us at: <b>support@rtaproducts.com</b> Free shipping within <u>the 48 Contiguous United States.</u>	 
	 For international customers & <b>AK-HI-PR</b> orders, <b>the customer is responsible for shipping costs plus any International local taxes or duties.</b>	

## ASSEMBLY STEPS

### STEP 1

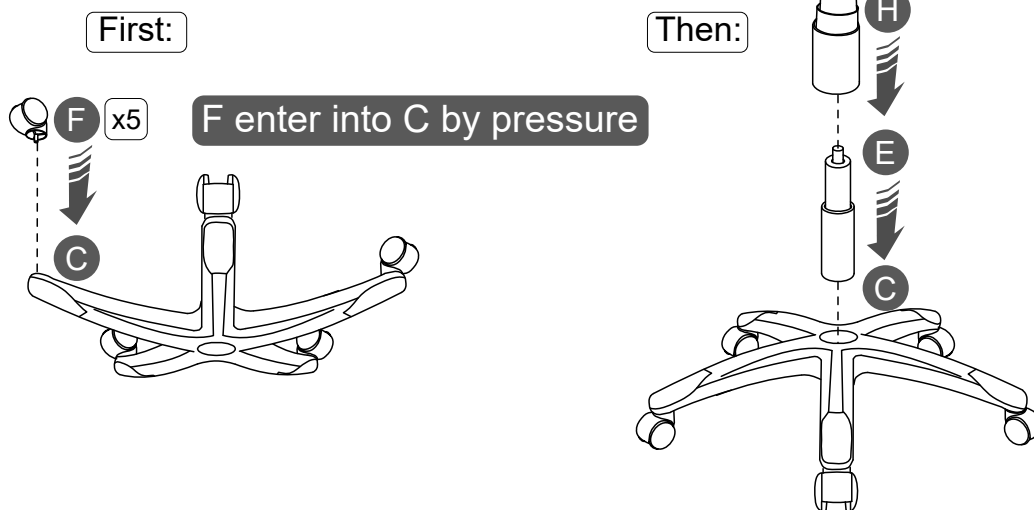

### STEP 2

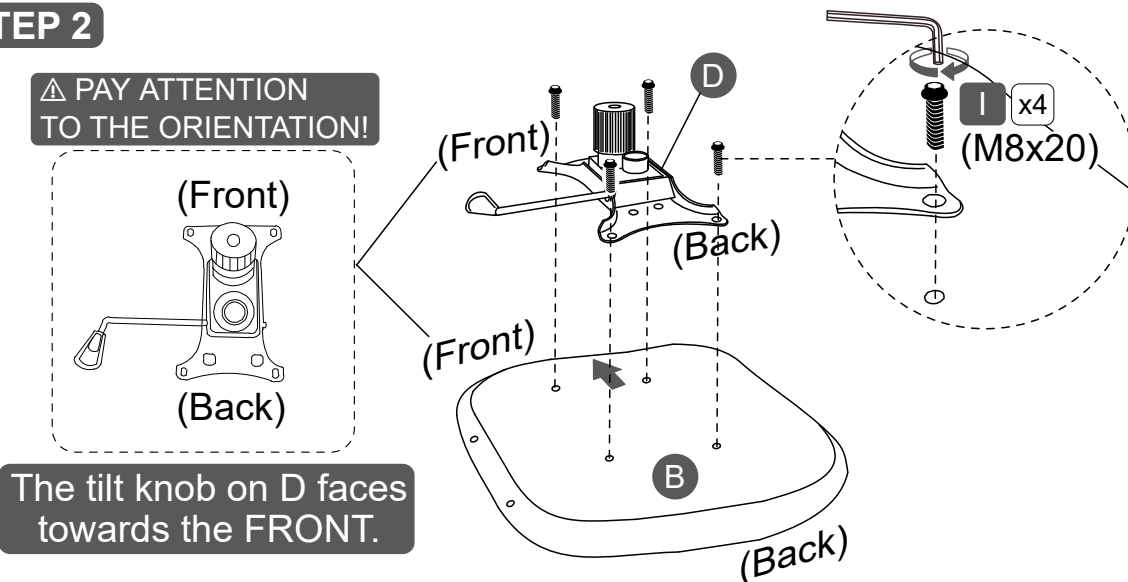

### STEP 3

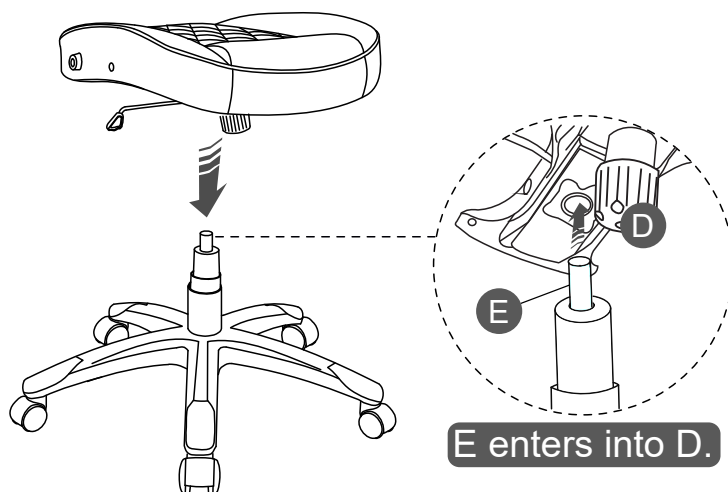

ASSEMBLY STEPS

STEP 4

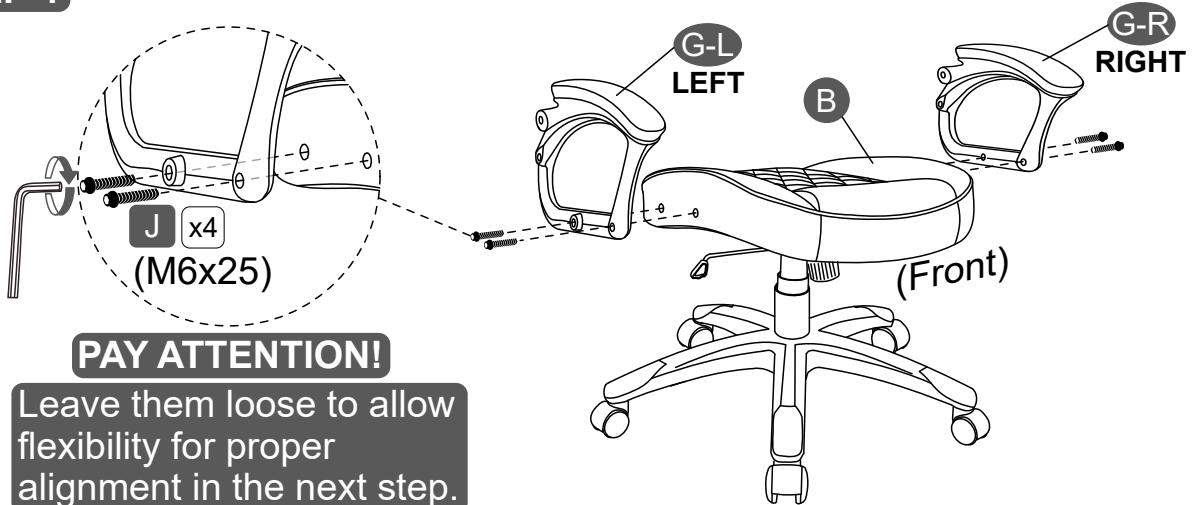

**PAY ATTENTION!**

Leave them loose to allow flexibility for proper alignment in the next step.

STEP 5

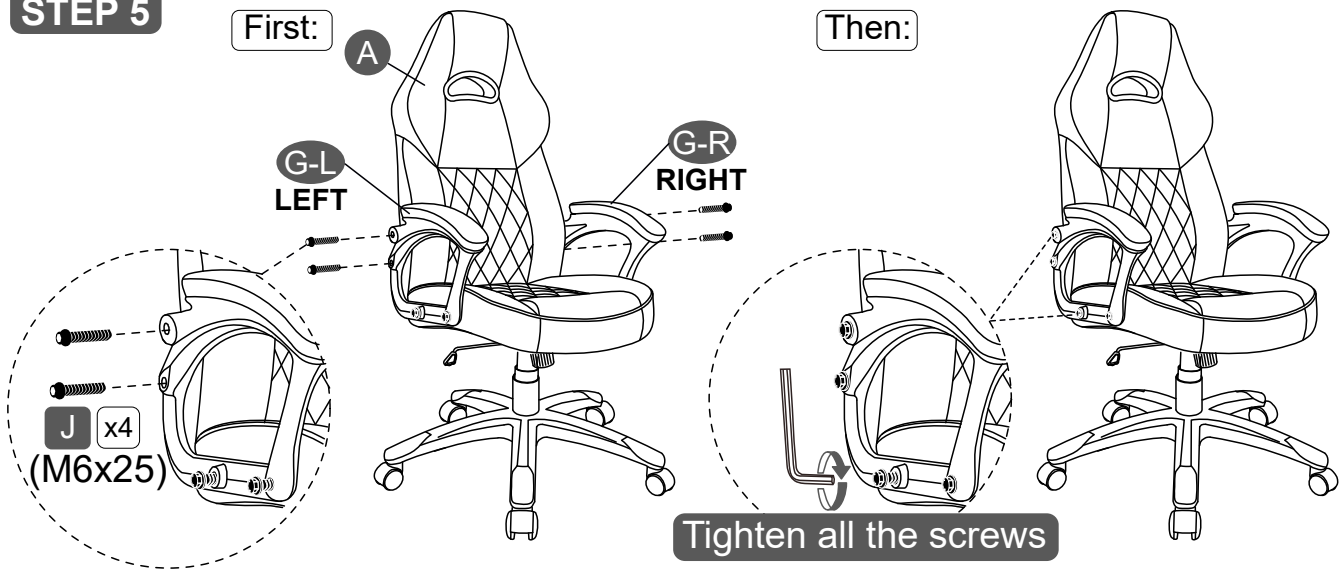

STEP 6

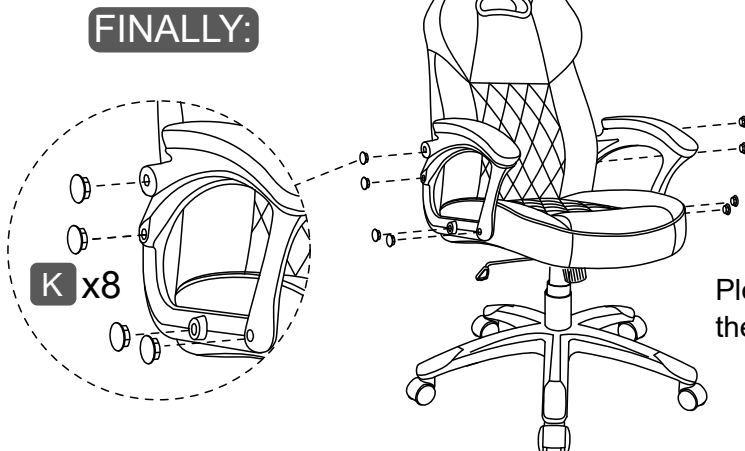

**ALL DONE!**

Please read all the warnings and tips on the next page, and enjoy your new chair!

## CHAIR'S FUNCTIONS

Pull Handle OUT to UNLOCK;  
Push Handle IN to LOCK.

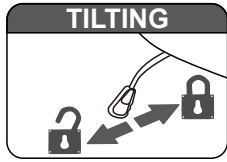

**TILTING**

Pull Handle UP.

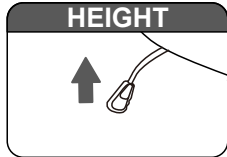

**HEIGHT**

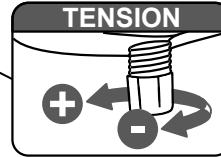

**TENSION**

Turn CLOCKWISE for less tension (-);  
COUNTERCLOCKWISE for more tension (+).

With less tension, the tilting feels easier.

## WARNINGS - Not paying attention to the following warnings could result in injuries.

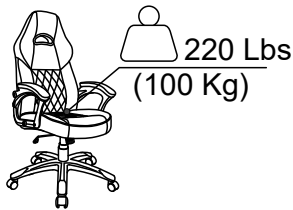

220 Lbs  
(100 Kg)



Only one person at a time and refrain from sitting on the edge of the seat to prevent the chair from tipping over.

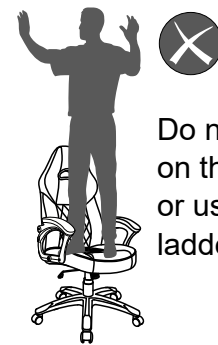

Do not stand on the chair or use it as a ladder.

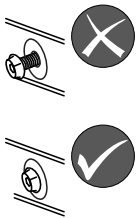

Do not use the chair if the frame parts are damaged, or if any of the screws are loose or missing.



Do not leave babies or toddlers unattended while seated on the chair, always ensure adult supervision. Keep children from playing with the chair for their safety.

## CARE AND MAINTENANCE

Clean with a soft cloth lightly damped in a solution of smooth soap and water.

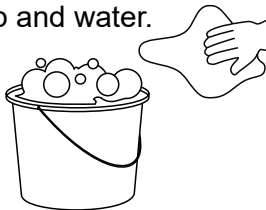

Do not use solvents or abrasive materials.



Do not expose to direct sunlight or to extreme environmental conditions.

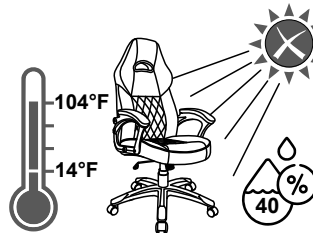

Inspect the chair thoroughly every 4 months and re-tighten the screws.

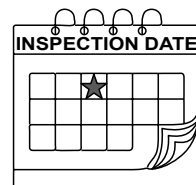

## LIMITED WARRANTY

To file a claim or request information, please email to: [warranty@rtaproducts.com](mailto:warranty@rtaproducts.com)

