

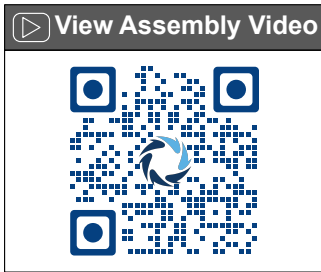



MODEL RTA-80X5

ASSEMBLY INSTRUCTIONS

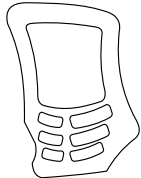

REV.7-BOL-9105-0825

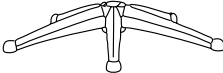
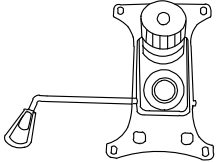

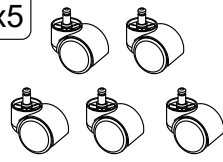
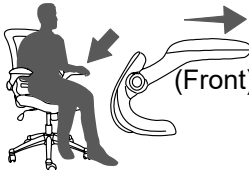
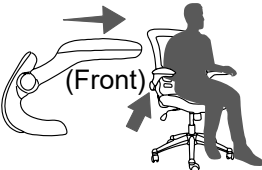
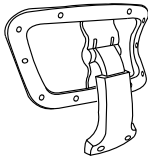
Thank you for purchasing our product!

MAIN PARTS LIST		
A Backrest 	B Seat 	C Nylon star base 
D Mechanism 	E Lift cylinder 	F Casters x5 
G-L Left armrest 	G-R Right armrest 	H Headrest 

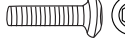
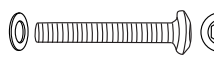
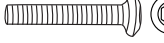
* Right and Left defined as sitting on the chair, not by looking at it.

HARDWARE			Qty.
I	M6x25 		4 Pcs
J	M6x20 		4 Pcs
K	M6x35 + Washer 		4 Pairs
L	M6x30 		4 Pcs
M	Hole covers 		4 Pcs

Tools (Included)	
Allen Wrench	

For support with assembly questions & replacement parts please email us at: support@rtaproducts.com



Free shipping within the 48 Contiguous United States.



For international customers & **AK-HI-PR** orders, the customer is responsible for shipping costs plus any International local taxes or duties.



technimobili.com



support@rtaproducts.com

ASSEMBLY STEPS

STEP 1 Attach F to C, then insert E into C.

F enters into C by pressure

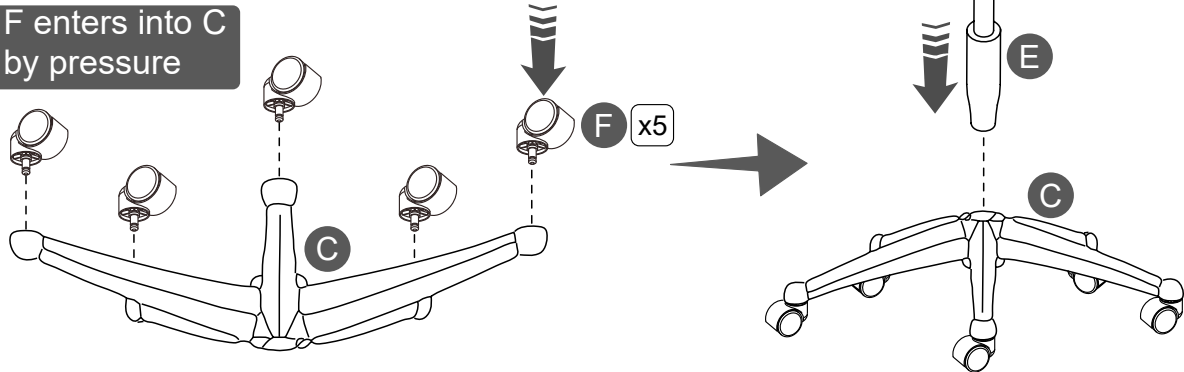

STEP 2 Assemble D to B with J.

⚠ PAY ATTENTION TO THE ORIENTATION!

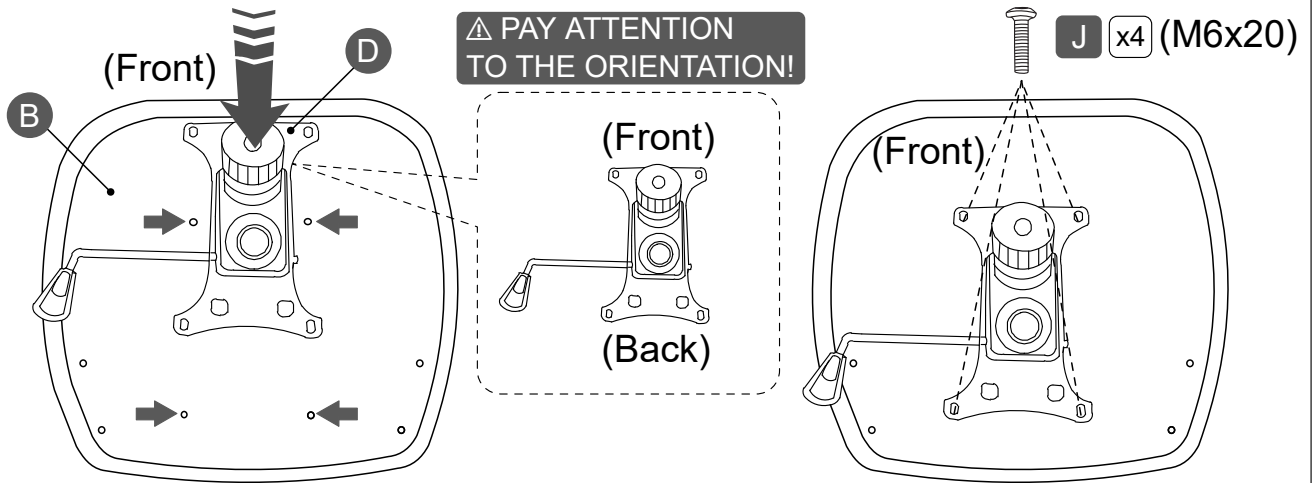

STEP 3 Assemble G-L and G-R to B with K.

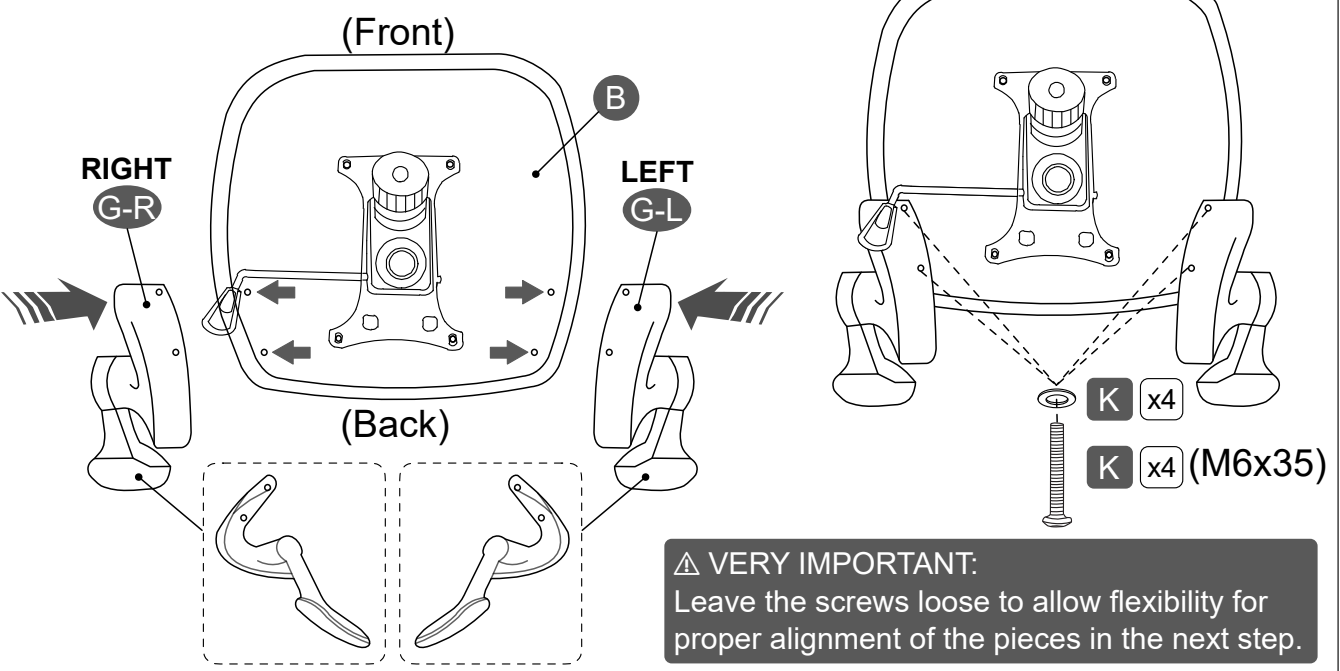

ASSEMBLY STEPS

STEP 4 Join the seat to the base.

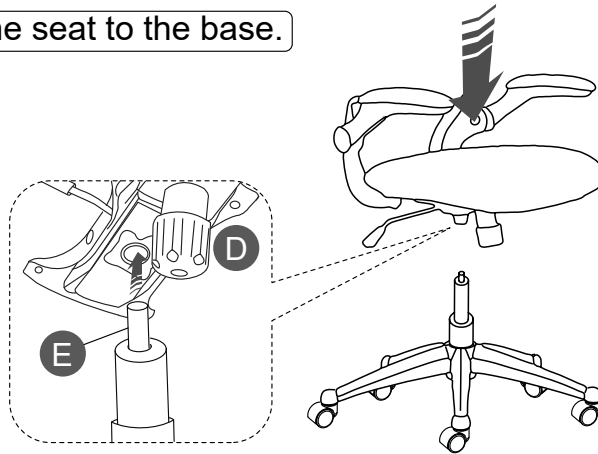

STEP 5 Assemble A to G-L and G-R with I.

⚠ VERY IMPORTANT:
Screw loosely to allow flexibility and proper alignment of the pieces.

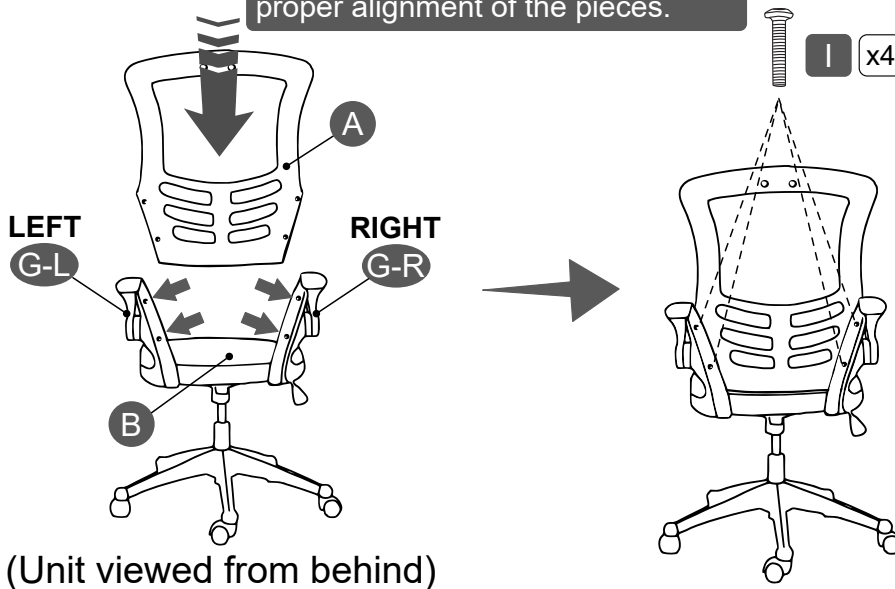

If holes don't seem to align, make sure the screws under the seat are loosened (from step 3). When finished, proceed to tighten all the screws from steps 3 and 5.

(Unit viewed from behind)

STEP 6 Cover the armrest holes with M.

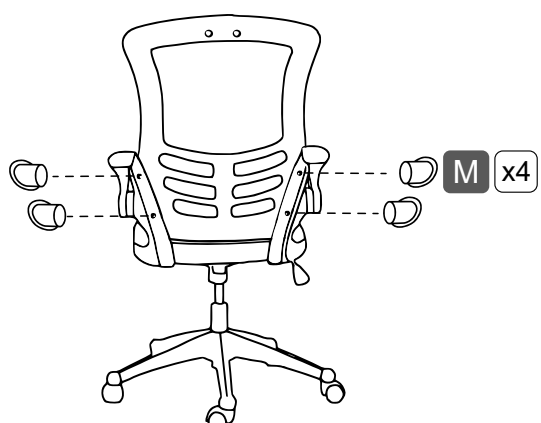

STEP 7 Finally, attach H to A with L.

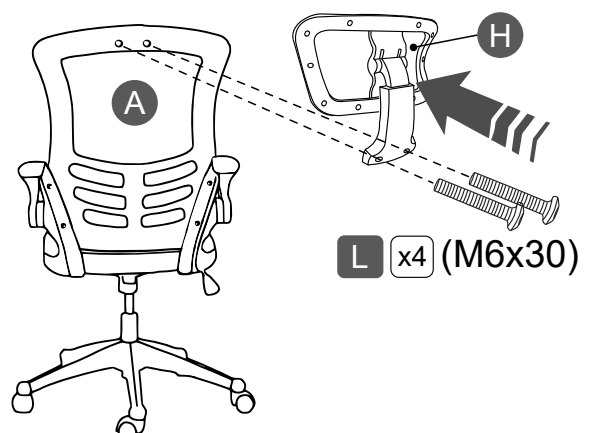

CHAIR'S FUNCTIONS

Pull knob **OUT** to raise/lower the headrest.

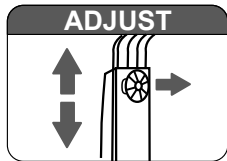

Pull Handle **OUT** to **UNLOCK**; Push Handle **IN** to **LOCK**.

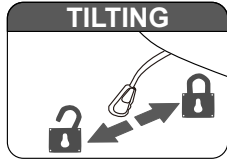

Pull Handle **UP**.

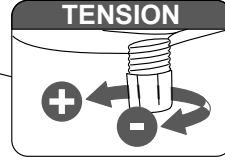
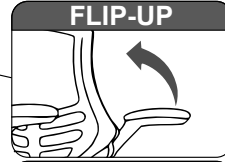
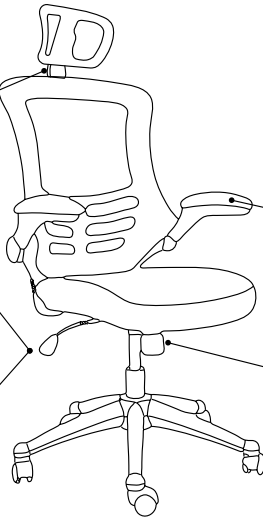
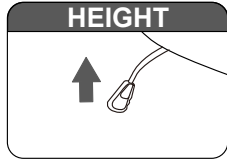

Turn the knob (+) for more tension, and (-) for less tension. Less tension means easier tilting.

WARNINGS - Not paying attention to the following warnings could result in injuries.



Only one person at a time and refrain from sitting on the edge of the seat to prevent the chair from tipping over.

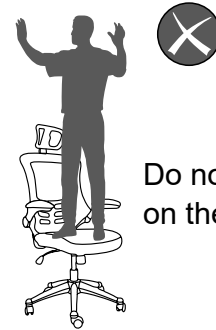

Do not stand on the chair.

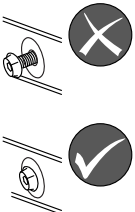

Do not use the chair if the frame parts are damaged, or if any of the screws are loose or missing.



Do not leave babies or toddlers unattended while seated on the chair, always ensure adult supervision. Keep children from playing with the chair for their safety.

CARE AND MAINTENANCE

Clean with a soft cloth lightly dampened in a solution of smooth soap and water.

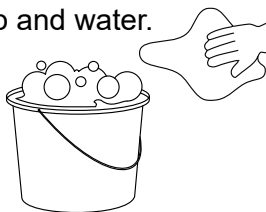

Do not use solvents or abrasive materials.



Do not expose to direct sunlight or to extreme environmental conditions.

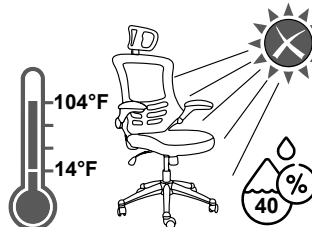

Inspect the chair thoroughly every 4 months and re-tighten the screws.

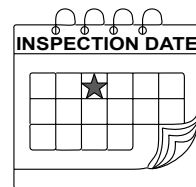

LIMITED WARRANTY



For details, please visit our website: Technimobili.com

To file a claim or request information, please email to: warranty@rtaproducts.com

