





# MODEL RTA-8050



## ASSEMBLY INSTRUCTIONS

REV.2-AFSI-9228-1025

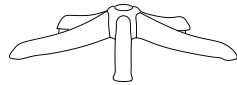
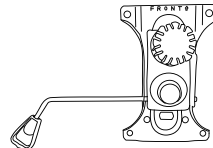

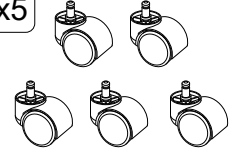
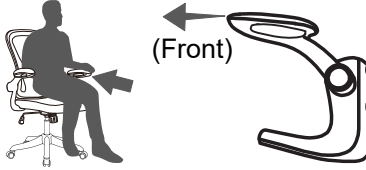
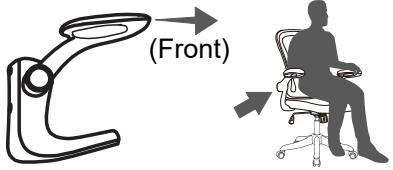
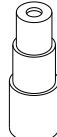
Thank you for purchasing our product!

MAIN PARTS LIST		
<b>A</b> Backrest 	<b>B</b> Seat 	<b>C</b> Nylon star base 
<b>D</b> Mechanism 	<b>E</b> Lift cylinder 	<b>F</b> Casters x5 
<b>G-L</b> Left armrest 		<b>G-R</b> Right armrest 
<b>H</b> Covers for lift cylinder x1 Set 		

Hardware			
Part #	QTY	SIZE/Description	Item
I	8	M6x20	
J	4	M6x30	

Tools (Included)	
M6 Allen Wrench	

For support with assembly questions & replacement parts please email us at: [support@rtaproducts.com](mailto:support@rtaproducts.com)



Free shipping within **the 48 Contiguous United States.**



For international customers & **AK-HI-PR** orders, **the customer is responsible for shipping costs plus any International local taxes or duties.**



[technimobili.com](http://technimobili.com)



[support@rtaproducts.com](mailto:support@rtaproducts.com)

## ASSEMBLY STEPS

### STEP 1

FIRST: Insert F into C using pressure.

THEN: Insert E into C and cover with H.

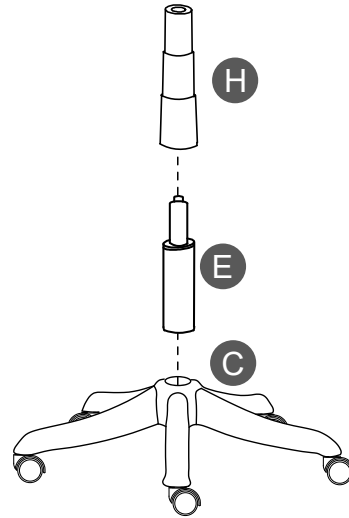
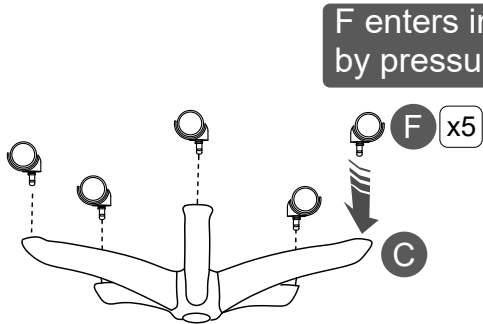

### STEP 2

Use I to attach G-L and G-R to A in their respective sides.

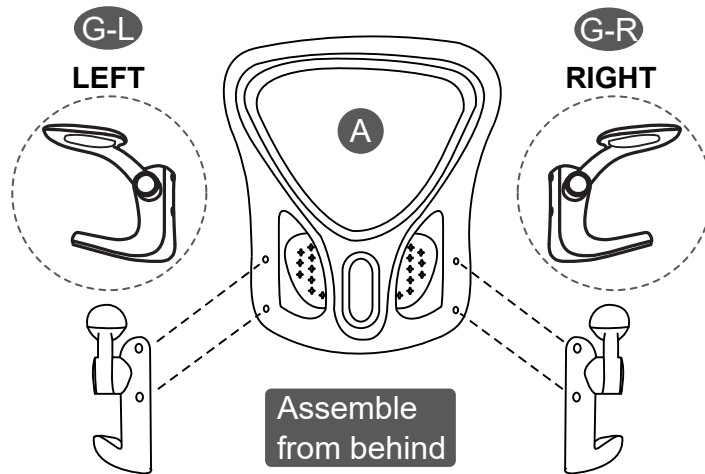

### PAY ATTENTION!

(Sitting on it, not by looking at it)

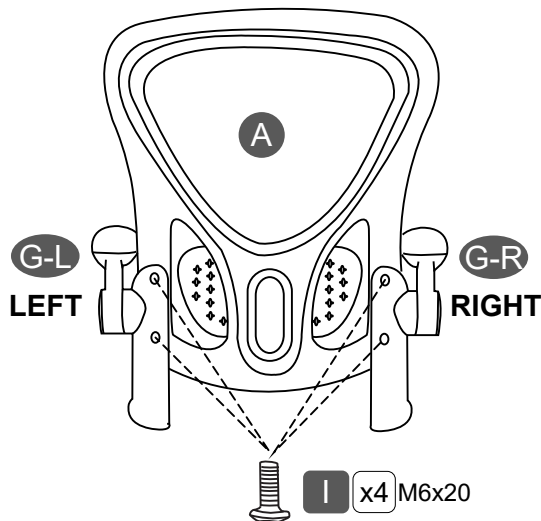
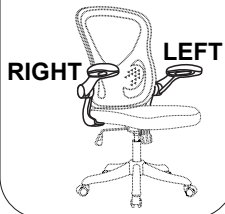

ASSEMBLY STEPS

**STEP 3** Use J to assemble B to G-L and G-R.

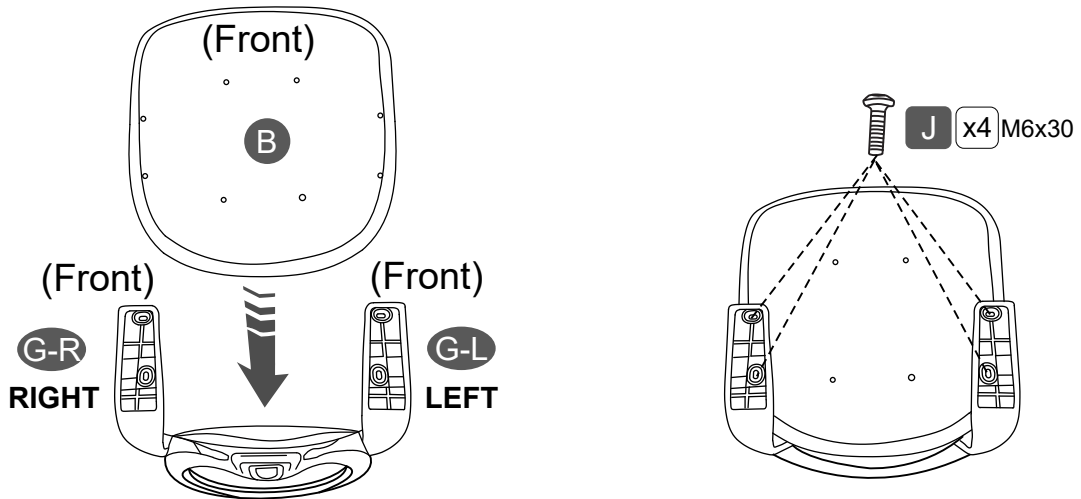

**STEP 4** Use I to assemble D to B.

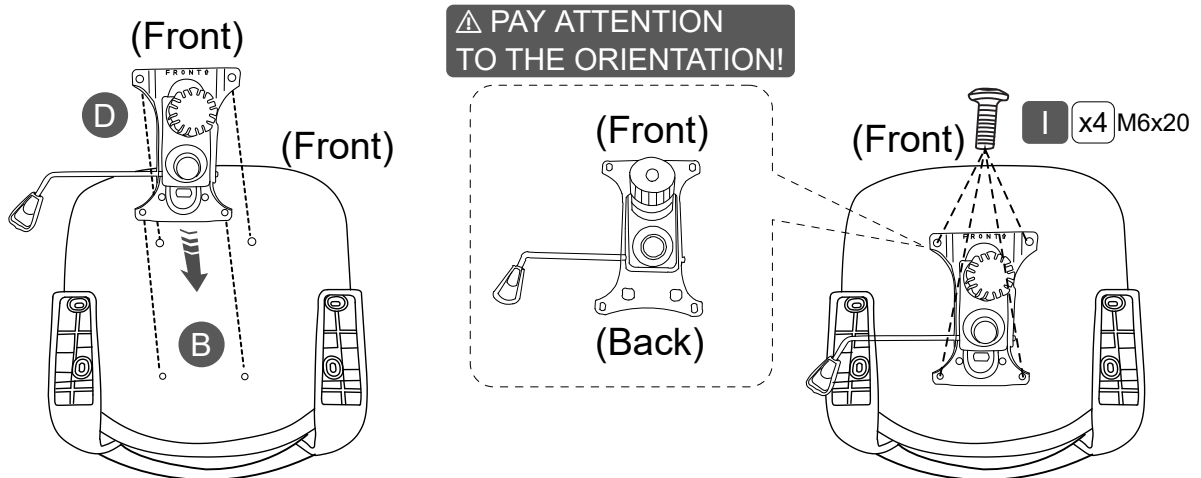

**STEP 5** Finally, join the seat to the base parts.

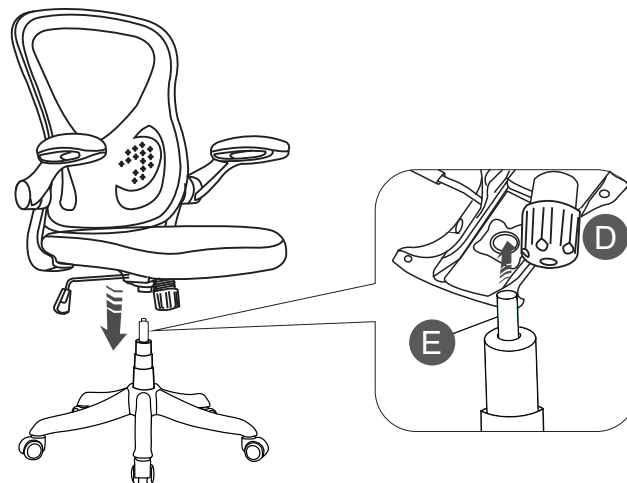

## CHAIR'S FUNCTIONS

Pull UP / push DOWN on handles.

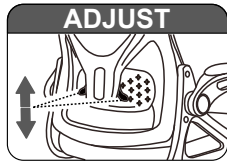

Pull Handle OUT to UNLOCK; Push Handle IN to LOCK.

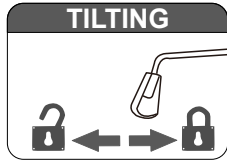

Pull Handle UP.

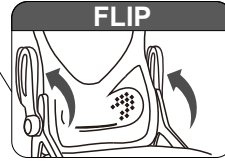
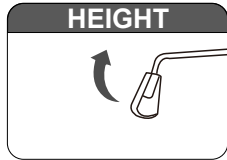

Flip arms UP or DOWN.

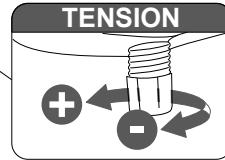

Turn the knob (+) for more tension, and (-) for less tension. Less tensions means easier tilting.

## WARNINGS - Not paying attention to the following warnings could result in injuries.

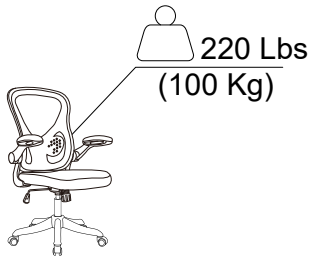

Only one person at a time and refrain from sitting on the edge of the seat to prevent the chair from tipping over.

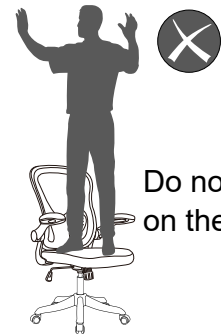

Do not stand on the chair.

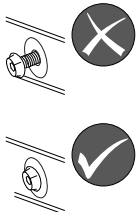

Do not use the chair if the frame parts are damaged, or if any of the screws are loose or missing.



Do not leave babies or toddlers unattended while seated on the chair, always ensure adult supervision. Keep children from playing with the chair for their safety.

## CARE AND MAINTENANCE

Clean with a soft cloth lightly dampened in a solution of smooth soap and water.

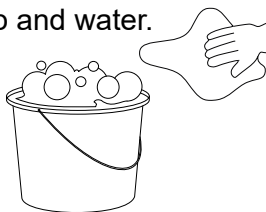

Do not use solvents or abrasive materials.



Do not expose to direct sunlight or to extreme environmental conditions.

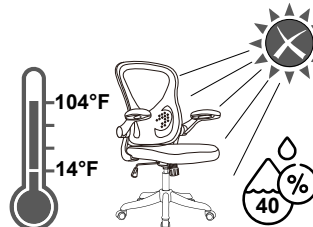

Inspect the chair thoroughly every 4 months and re-tighten the screws.

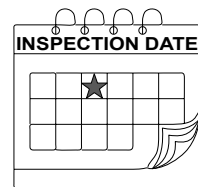

## LIMITED WARRANTY



For details, please visit our website: [Technimobili.com](http://Technimobili.com)

To file a claim or request information, please email to: [warranty@rtaproducts.com](mailto:warranty@rtaproducts.com)

