

MODEL RTA-2027C

ASSEMBLY INSTRUCTIONS

REV.1-FT-8910-0625



Thank you for purchasing our product!

Hardware			
No.	Item		Qty.
I	M6x20		4 Pcs
J	M6x25		4 Pcs
K	M6x35		6 Pcs
L	Ø6mm x Ø16mm x 1mm		12 Pcs

Tools (Included)	
M5, 70mm x 70mm Allen Wrench	

MAIN PARTS LIST				
A Backrest 	B Seat 	C Nylon star base 	D Mechanism 	E Lift cylinder
F Casters 	G-L Left armrest 		G-R Right armrest 	
	H Covers for lift cylinder 			

* The left metal bracket on the seat is loose, while the right is stiff and can only move once the chair is assembled.

For Support, Assembly Questions & Replacement Parts Within the 48 Contiguous United States:
Please email us at: support@rtaproducts.com

Replacement Parts for International Customers & **AK-HI-PR** orders:
RTA Products will replace the part free of charge, while **the customer is responsible for shipping costs plus any International local taxes or duties.**

ASSEMBLY STEPS

STEP 1

FIRST: Attach F to the legs of C.

THEN: Place E into C and cover it with H.

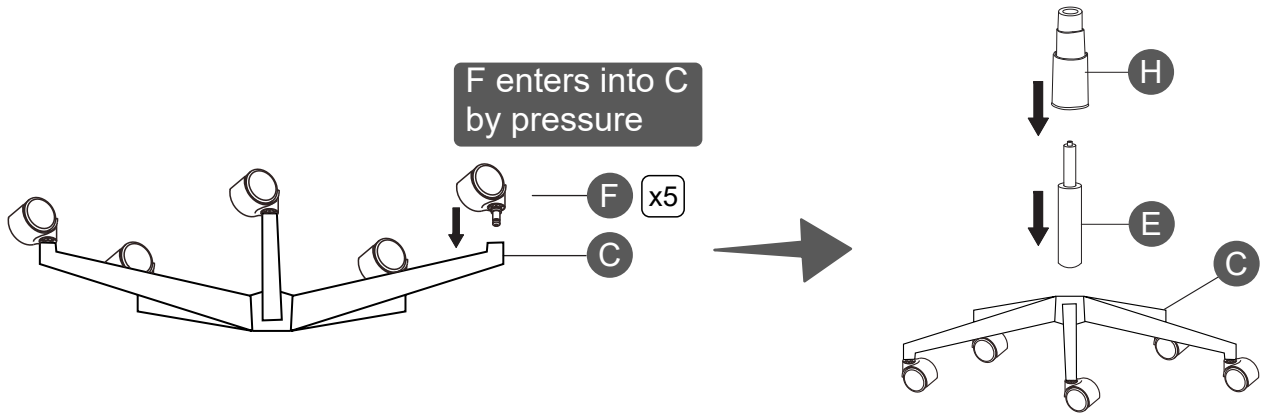

STEP 2

Attach D to B with I and L.

⚠ PAY ATTENTION:
The Knob from D faces towards the FRONT.

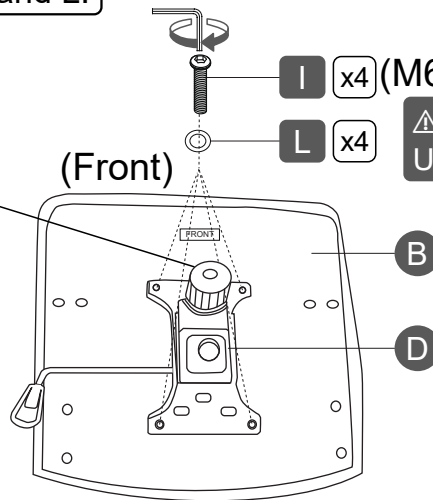

⚠ PAY ATTENTION:
Use the correct screws.

STEP 3

Attach G-L and G-R to A in their respective sides with K.

⚠ VERY IMPORTANT:
Leave the screws loose to allow flexibility for proper alignment of the pieces in the next step.

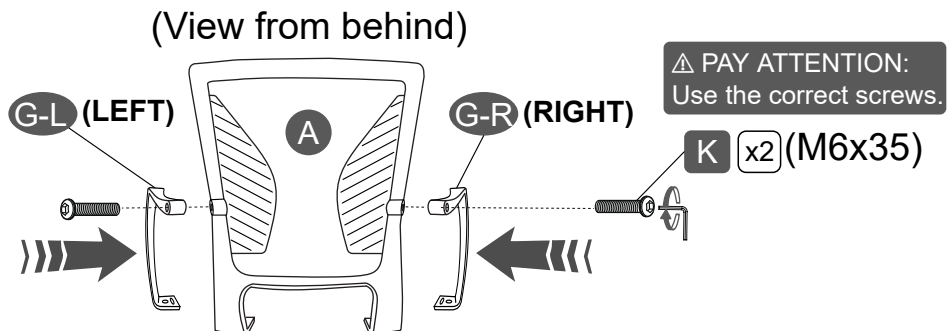

ASSEMBLY STEPS

STEP 4 Attach A, G-L and G-R to B with J and K.

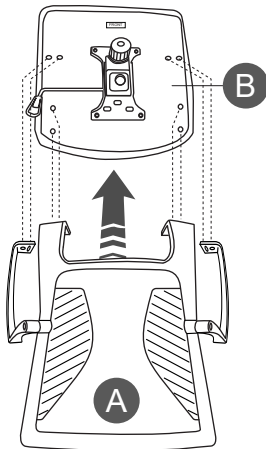

(View from behind)

⚠ VERY IMPORTANT:
Screw loosely to allow flexibility
for proper alignment; tighten
only after all are in place.

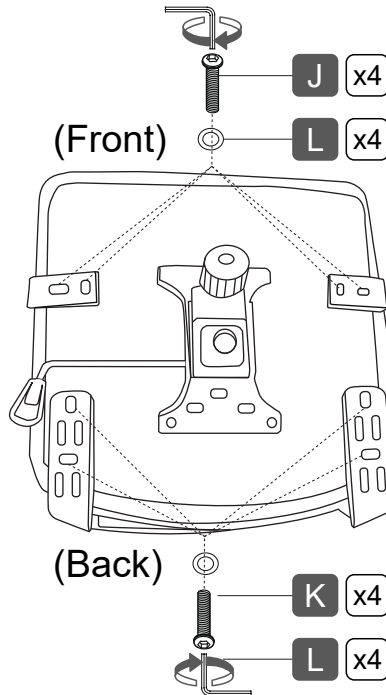

⚠ PAY ATTENTION!
SHORTER screws J
for the FRONT holes.

⚠ PAY ATTENTION!
LONGER screws K
for the BACK holes.

STEP 5 Join the seat with the base.

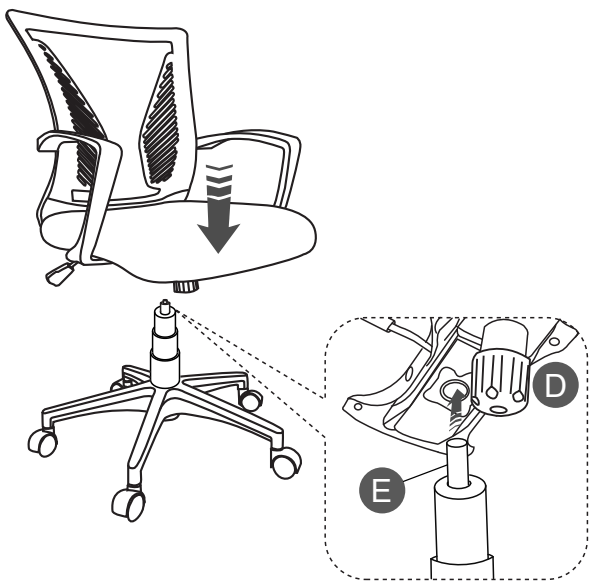

STEP 6 FINALLY, tighten the screws K.

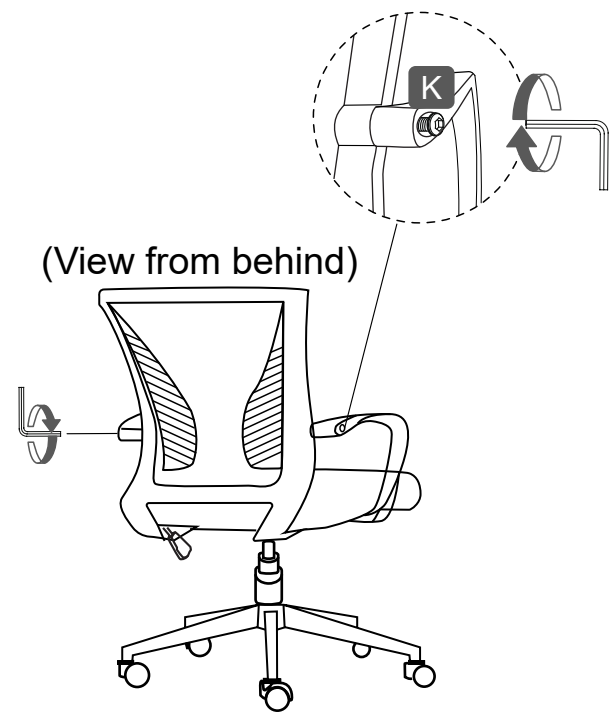

CHAIR'S FUNCTIONS

Pull Handle OUT to UNLOCK;
Push Handle IN to LOCK.

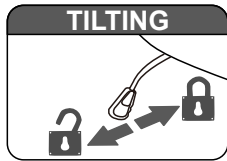

Pull Handle UP.

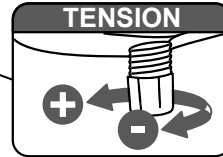
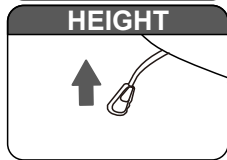

Turn CLOCKWISE for less tension (-);
COUNTERCLOCKWISE for more tension (+).
With less tension, the tilting feels easier.

WARNINGS - Not paying attention to the following warnings could result in injuries.

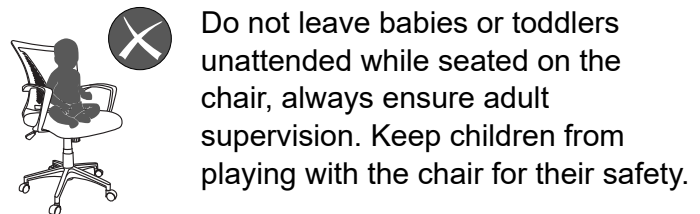
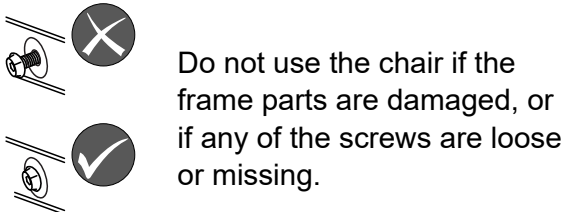
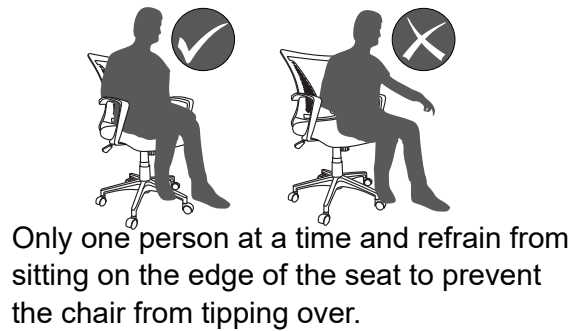
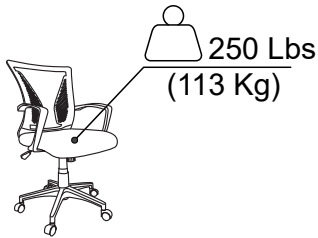

CARE AND MAINTENANCE

Clean with a soft cloth lightly dampened in a solution of smooth soap and water.

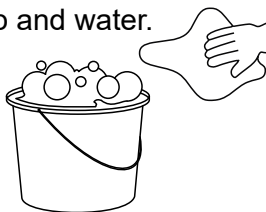

Do not use solvents or abrasive materials.



Do not expose to direct sunlight or to extreme environmental conditions.

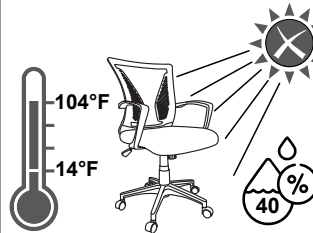

Inspect the chair thoroughly every 4 months and re-tighten the screws.

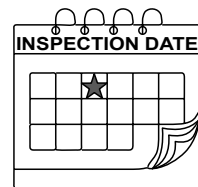

LIMITED WARRANTY



For details, please visit our website:
Technimobili.com

To file a claim or request information, please email to:
warranty@rtaproducts.com

