







Elegant textured boucle office chair
MODEL RTA-3270C
ASSEMBLY INSTRUCTIONS

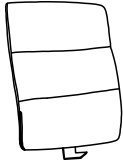

REV.3-AFSI-A9291-0126

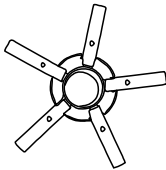
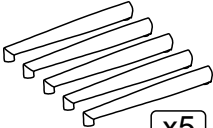

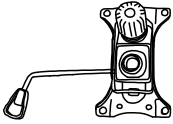
Thank you for
purchasing our product!

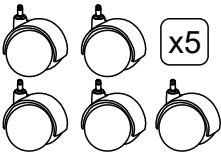
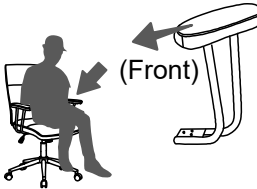
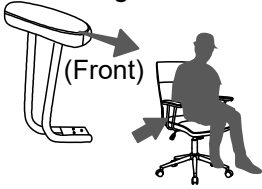
<p>Do a quick inventory of all the parts and hardware listed below.</p> 	<p>For Support, assembly questions & Replacement Parts within the 48 Contiguous United States:</p> <p>Please email us at: support@rtaproducts.com</p> 	<p>Replacement Parts for International Customers & AK-HI-PR orders: RTA Products will replace the part free of charge, while the customer is responsible for shipping costs plus any International local taxes or duties.</p>
---	---	---

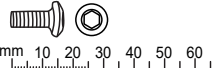
MAIN PARTS LIST				
<p>A Backrest</p> 	<p>B Seat</p> 	<p>C-1 Star base</p> 	<p>C-2 Legs</p>  <p>x5</p>	<p>C-3 Cover for base</p>  <p>NOTE: This piece comes attached to the base C-1</p>
<p>D Mechanism</p> 	<p>E Lift cylinder</p> 	<p>F Casters</p>  <p>x5</p>	<p>G-L Left armrest</p>  <p>(Front)</p>	<p>G-R Right armrest</p>  <p>(Front)</p>

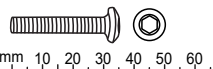
HARDWARE LIST			
Part #	QTY	SIZE/Description	Item
I	5	M6x12	 mm 10 20 30 40 50 60
J	6	M6x25	 mm 10 20 30 40 50 60
K	4	M6x20	 mm 10 20 30 40 50 60
L	4	M6x30	 mm 10 20 30 40 50 60

INCLUDED TOOLS	
M6 Allen Wrench	

ASSEMBLY STEPS

STEP 1

1st: Remove C-3 from the base C-1.

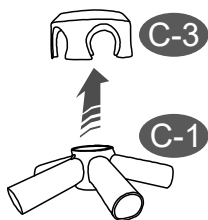

2nd: Insert the legs C-2 into the base C-1.

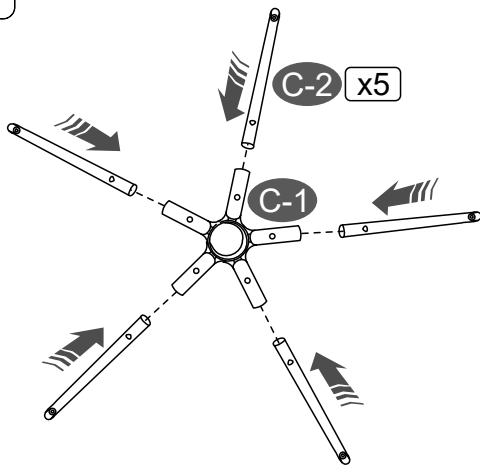

3rd: Use screws I to assemble the legs.

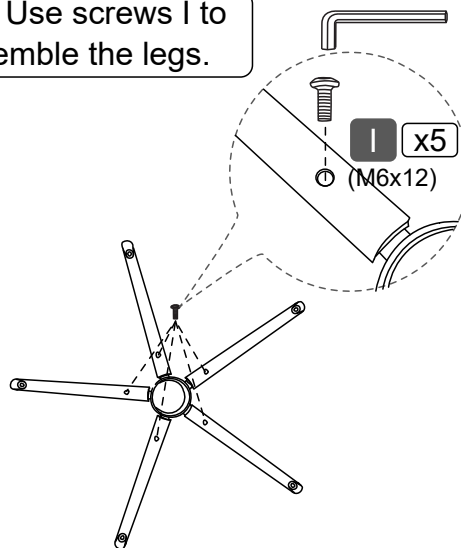

STEP 2

1st: Insert the casters F into the legs C-2 using pressure.

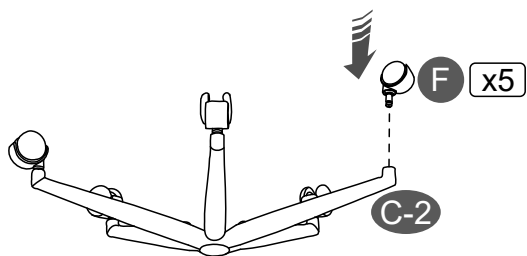

2nd: Insert the gas lift E and the cover C-3 in the middle of the base C-1.

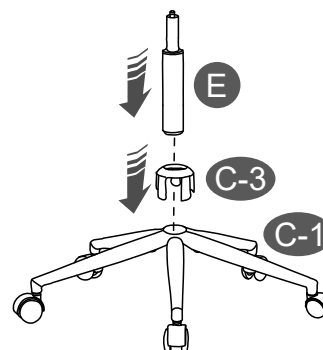

STEP 3

Use screws J to assemble G-L and G-R to B on their respective sides.

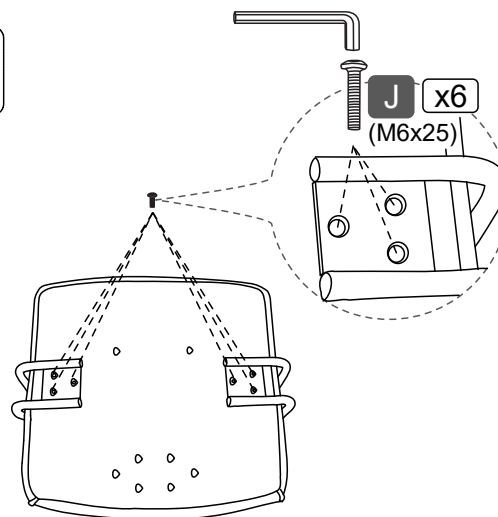
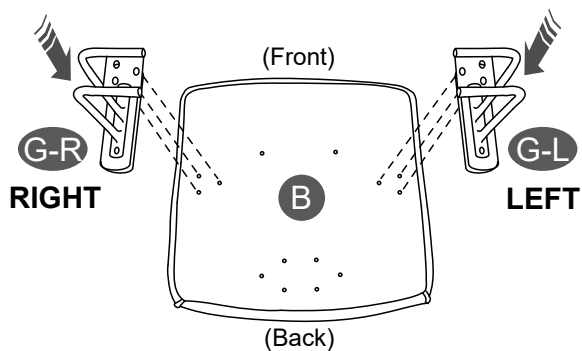

STEP 4

1st: Place the mechanism D over the seat B with its knob facing towards the front.

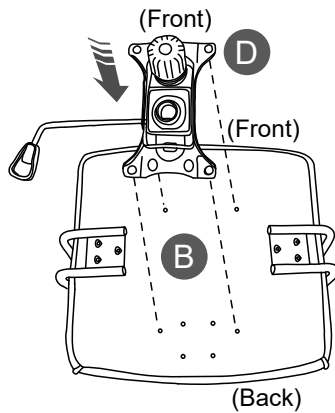

2nd: Use screws K to secure D to B.

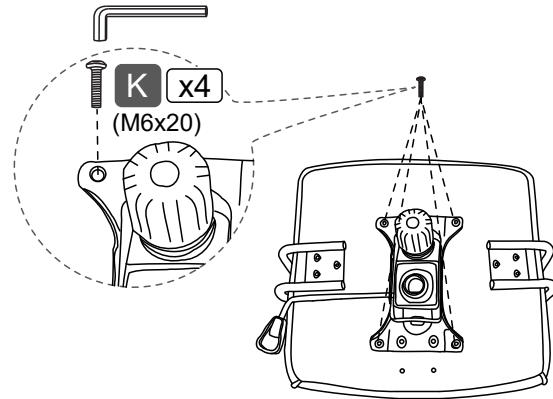

STEP 5

⚠ PAY ATTENTION!

- Place A coming DOWN FROM ABOVE and at an angle.
- The front holes of A go over D.
- Screw on the front holes first, and leave them loose.

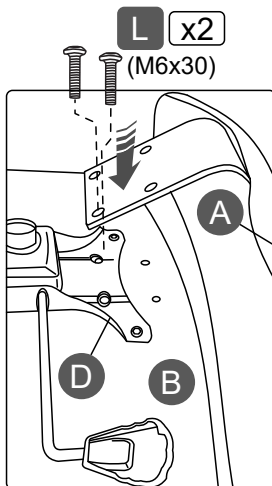

1st: Use screws L to attach the 2 front holes of A to B through D, but leave loose.

⚠ A coming from ABOVE and at an angle.

2nd: Use screws L to attach the back holes of A to B, and tighten all screws.

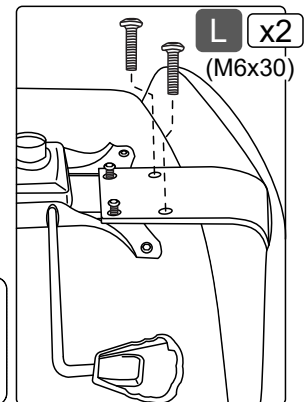

STEP 6

Join the seat to the base parts so the tip of the gas lift E enters into the big hole of the mechanism D.

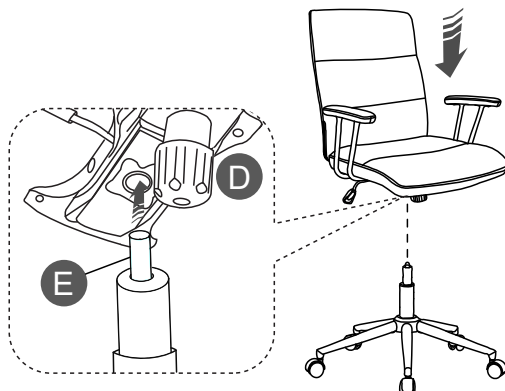

ALL DONE! Please read the safety warnings on the next page.

CHAIR'S FUNCTIONS

Pull Handle UP.

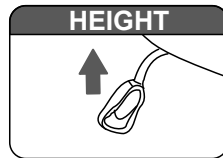

Pull Handle OUT to UNLOCK;
Push Handle IN to LOCK.

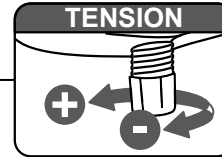
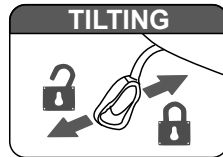

Turn **CLOCKWISE** for less tension (-); **COUNTERCLOCKWISE** for more tension (+).
With less tension, the tilting feels easier.

WARNINGS - Not paying attention to the following warnings could result in injuries.



Do not use the chair if the frame parts are damaged, or if any of the screws are loose or missing.



Only one person at a time and refrain from sitting on the edge of the seat to prevent the chair from tipping over.

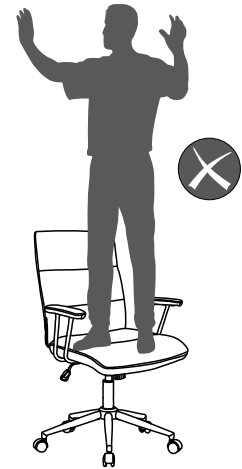

Do not stand or use the chair as ladder.

WEIGHT LIMIT



Do not leave babies or toddlers unattended while seated on the chair, always ensure adult supervision. Keep children from playing with the chair for their safety.

CARE AND MAINTENANCE

Clean with a soft cloth lightly damped in a solution of smooth soap and water.

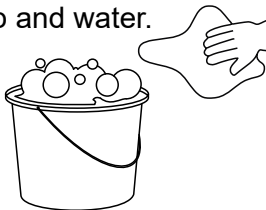

Do not use solvents or abrasive materials.



Do not expose to direct sunlight or to extreme environmental conditions.

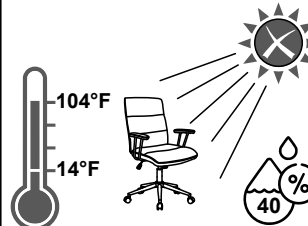

Inspect the chair thoroughly every 4 months and re-tighten the screws.

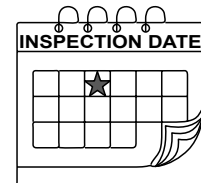

WARRANTY



LIMITED 2 YEAR WARRANTY

For details on the Warranty Policy, please visit online:
www.technimobili.com