

# MODEL RTA-2050C

## ASSEMBLY INSTRUCTIONS

REV.2-WT-8836-0525

For Support, assembly questions & Replacement Parts within the 48 Contiguous United States:



Please email us at:





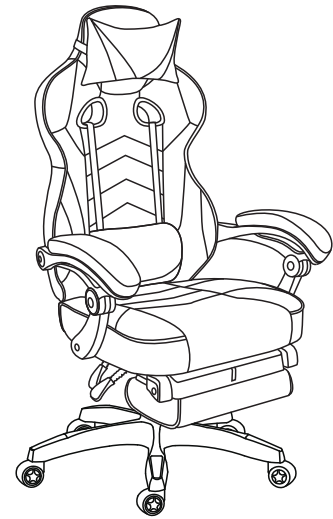

[support@rtaproducts.com](mailto:support@rtaproducts.com)

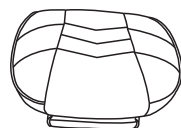

Replacement Parts for International Customers & **AK-HI-PR** orders: RTA Products will replace the part free of charge, while **the customer is responsible for shipping costs plus any International local taxes or duties.**

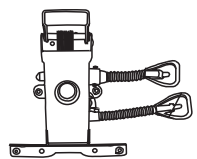

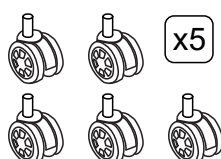
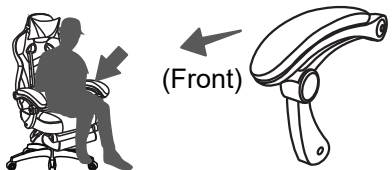
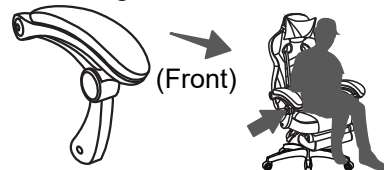
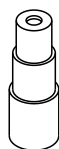
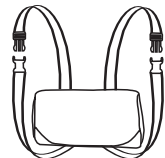

Thank you for purchasing our product!

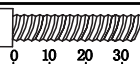
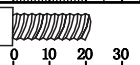
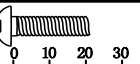
### MAIN PARTS LIST

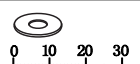
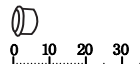
<b>A</b> Backrest 	<b>B</b> Seat 	<b>C</b> Nylon star base 	<b>D</b> Mechanism 	<b>E</b> Lift cylinder 	
<b>F</b> Casters 	<b>G-L</b> Left armrest 		<b>G-R</b> Right armrest 		<b>H</b> Covers for lift cylinder 
<b>I</b> Lumbar pillow 	<b>J</b> Neck pillow 		<b>HARDWARE LIST</b>		

Part #	QTY	SIZE/Description	Item
K	4	M8x35	
L	3	M8x20	
M	4	M6x20	
N	3	Ø8, Ø12 O-Ring	
O	7	Ø8, Ø17 Washer	
P	4	Ø18 Caps	

### INCLUDED TOOLS

1	M5 Allen Wrench	
1	M4 Allen Wrench	

## ASSEMBLY STEPS

**STEP 1** PAY ATTENTION! Screw loosely, don't tighten until all screws are in place.

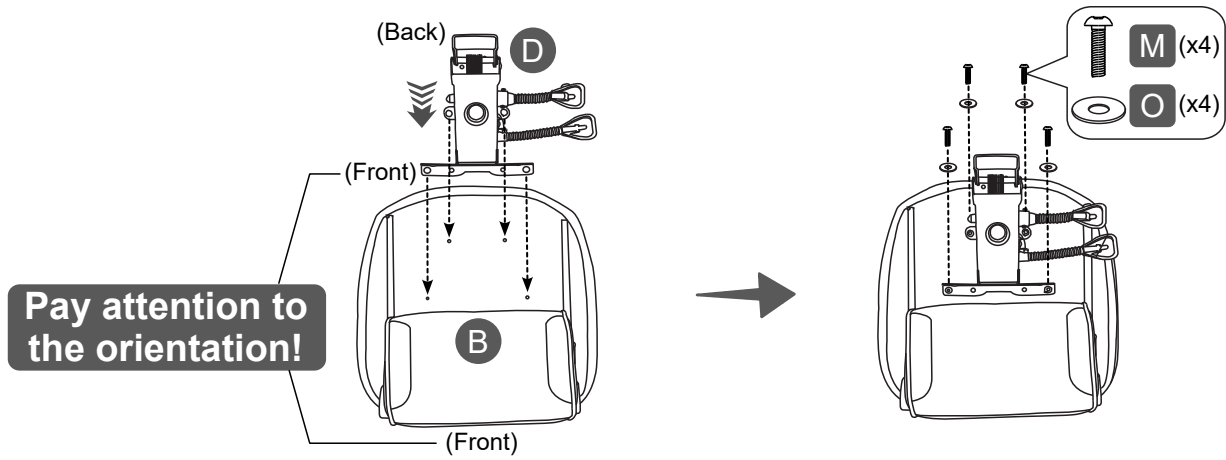

**STEP 2**

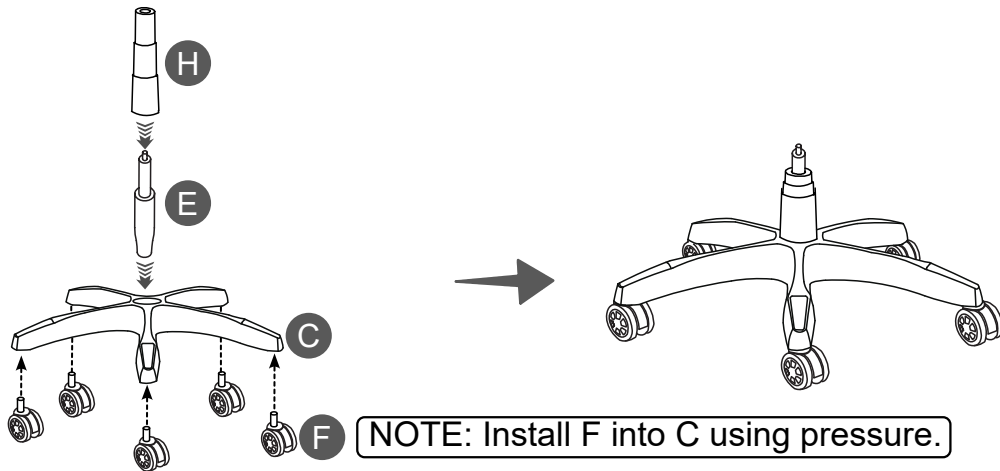

**STEP 3**

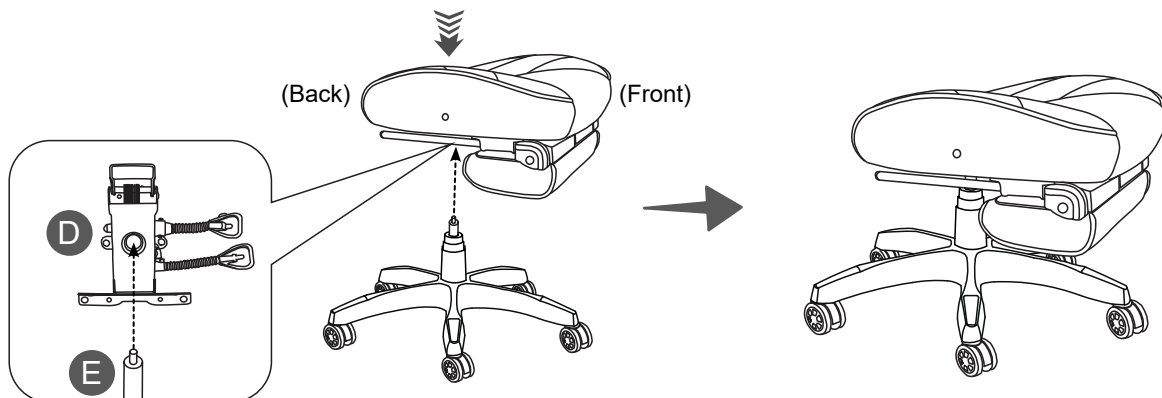

## ASSEMBLY STEPS

### STEP 4

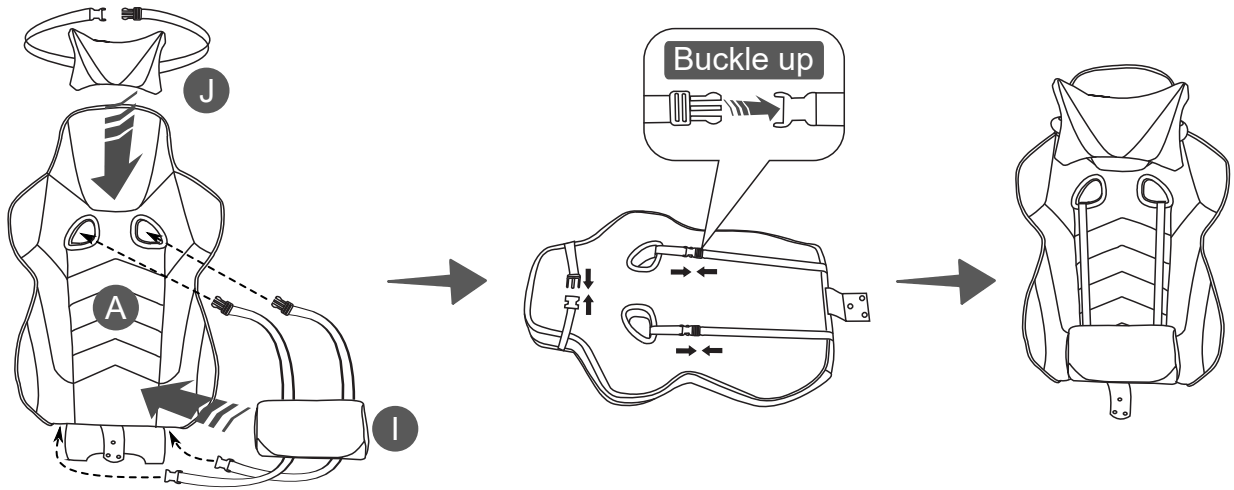

### STEP 5

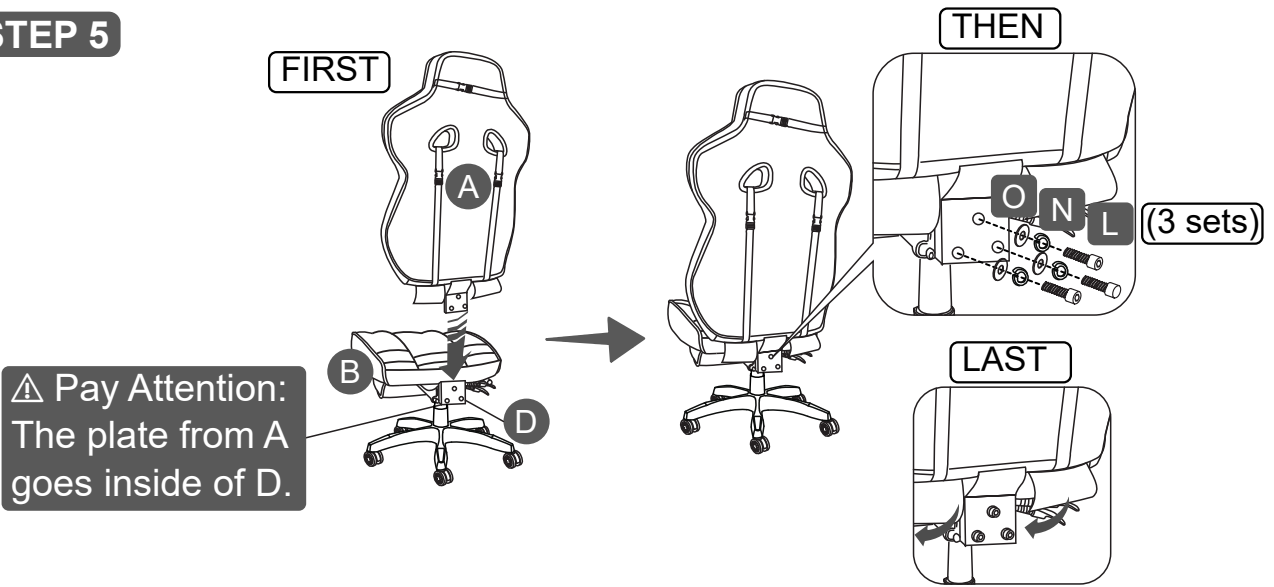

### STEP 6

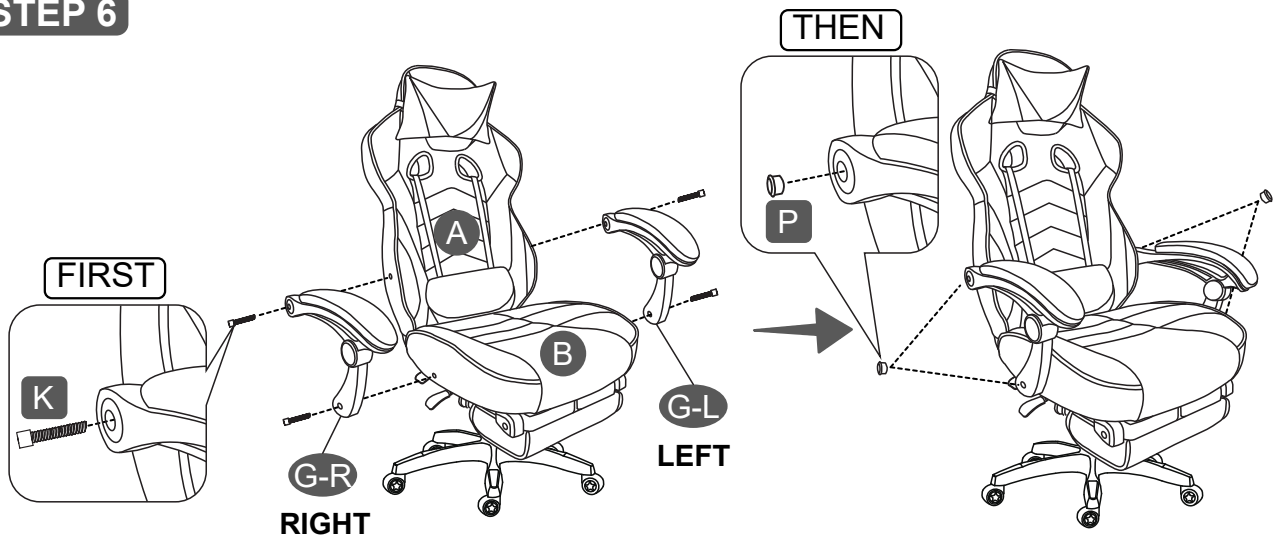

## CHAIR'S FUNCTIONS

**RECLINING**  
 Back Handle:  
 Lift to unlock.  
  
 Lower to lock.

**HEIGHT**  
 Lift the  
 Front  
 Handle  

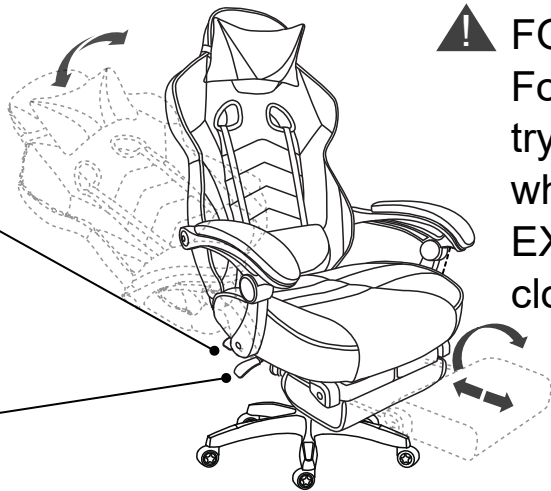

**! FOOTREST WARNING!**  
 For your safety, NEVER try to get off the chair while the footrest is EXTENDED, you must close it first.

**FOOTREST !**

- Pull out
- Flip over

## WARNINGS - Not paying attention to the following warnings could result in injuries.

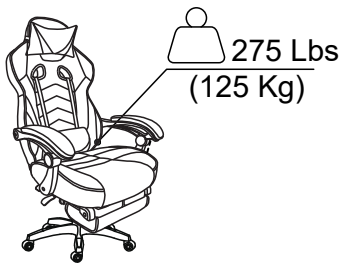

275 Lbs  
(125 Kg)



Only one person at a time and refrain from sitting on the edge of the seat to prevent the chair from tipping over.

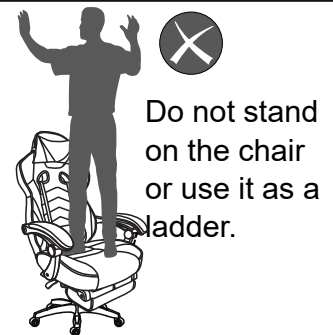

Do not stand on the chair or use it as a ladder.

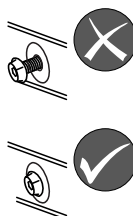

Do not use the chair if the frame parts are damaged, or if any of the screws are loose or missing.



Do not leave babies or toddlers unattended while seated on the chair, always ensure adult supervision. Keep children from playing with the chair for their safety.

## CARE AND MAINTENANCE

Clean with a soft cloth lightly damped in a solution of smooth soap and water.

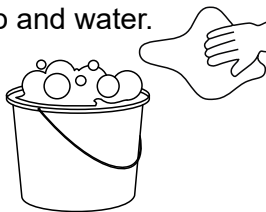

Do not use solvents or abrasive materials.



Do not expose to direct sunlight or to extreme environmental conditions.



Inspect the chair thoroughly every 4 months and re-tighten the screws.

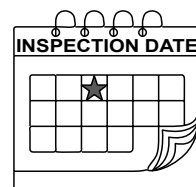

## LIMITED WARRANTY

For details on the Warranty Policy, please visit online: [www.technimobili.com](http://www.technimobili.com)  
 Or contact us by email: [warranty@rtaproducts.com](mailto:warranty@rtaproducts.com)