

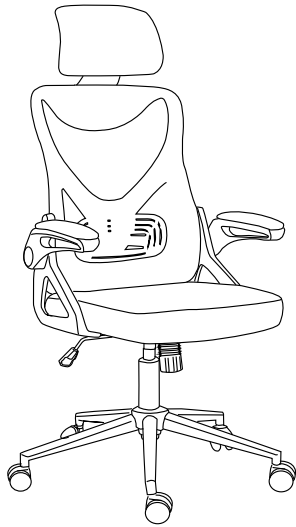







MODEL RTA-3263C



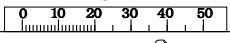

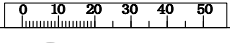
ASSEMBLY INSTRUCTIONS

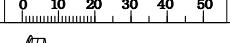
REV.3-AFSI-A9104-0925)

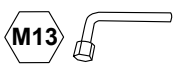

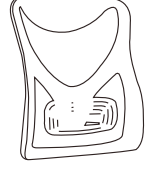
Thank you for purchasing our product!

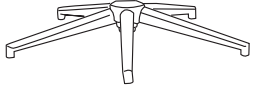
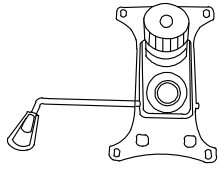
Hardware		
No.	Item	Qty.
J	M6x22  	10
K	M6x35  	4
L	Ø8, Ø16  	8
M	Caps 	4
Tools (Included)		
M6 Allen wrench		
M13 Socket wrench		

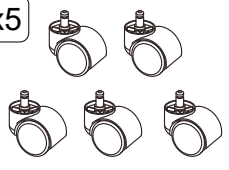
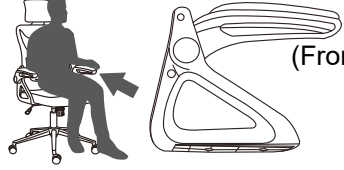
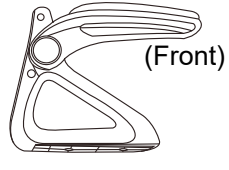
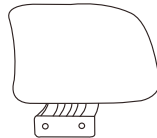
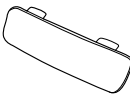
MAIN PARTS LIST		
A Backrest 	B Seat 	C Metal star base 
D Mechanism 	E Lift cylinder 	F Casters x5 
G-L Left armrest  (Front)	G-R Right armrest  (Front)	
H Headrest 	I Cover for headrest 	

For support with assembly questions & replacement parts please email us at: support@rtaproducts.com



Free shipping within **the 48 Contiguous United States.**



For international customers & **AK-HI-PR** orders, **the customer is responsible for shipping costs plus any International local taxes or duties.**



technimobili.com



support@rtaproducts.com

ASSEMBLY STEPS

STEP 1

First insert F into C, then place E into C.

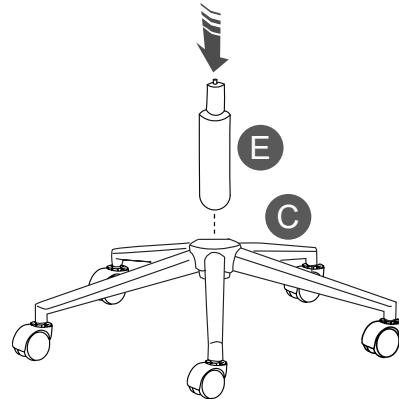
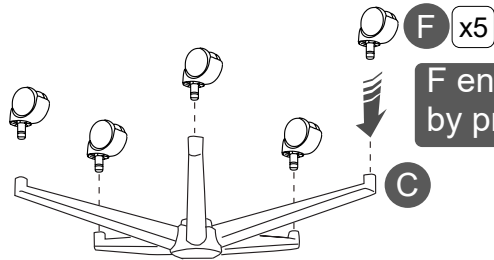

STEP 2

First: Check if G-L and G-R flip smoothly.

THEN (and if needed): Use the socket wrench tool to tighten or loosen the armrests.

Adjust if the armrests are too tight or too loose.

(Front)

G-L + G-R
LEFT RIGHT

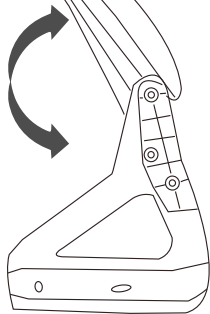

(Built-in screw on the internal side)

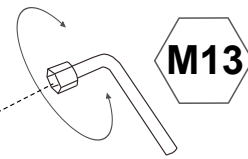
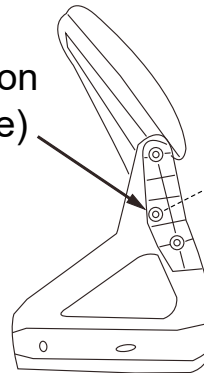

TIP! We recommend to save this tool.

STEP 3

Attach G-L and G-R to A with J and cover with M.

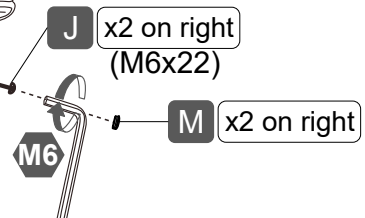
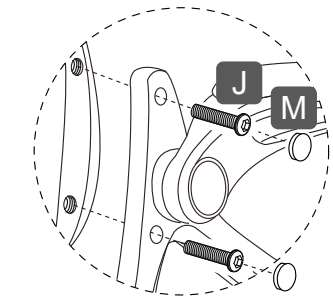
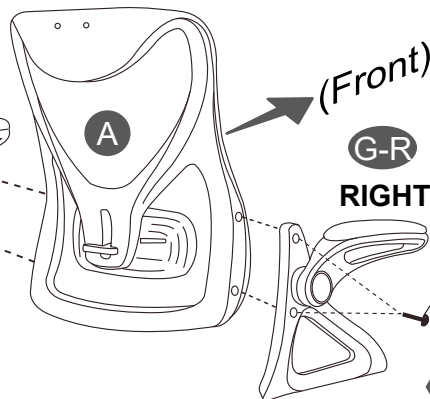
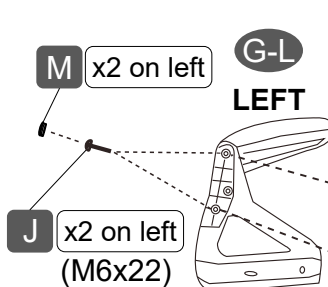

⚠ PAY ATTENTION:
Left and Right are defined by you sitting on the chair, not by looking at it.

ASSEMBLY STEPS

STEP 4 Attach B to G-L and G-R with K and L.

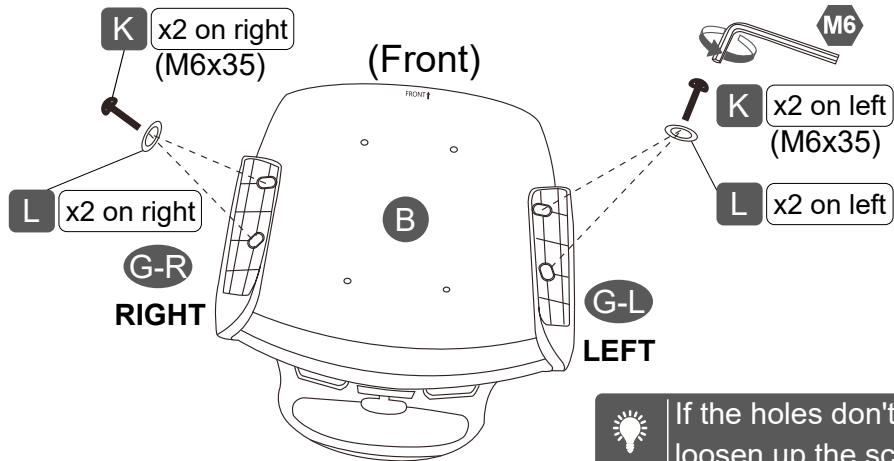

TIP! If the holes don't seem to align, loosen up the screws M used on step 3.

STEP 5 Attach D to B with J and L.

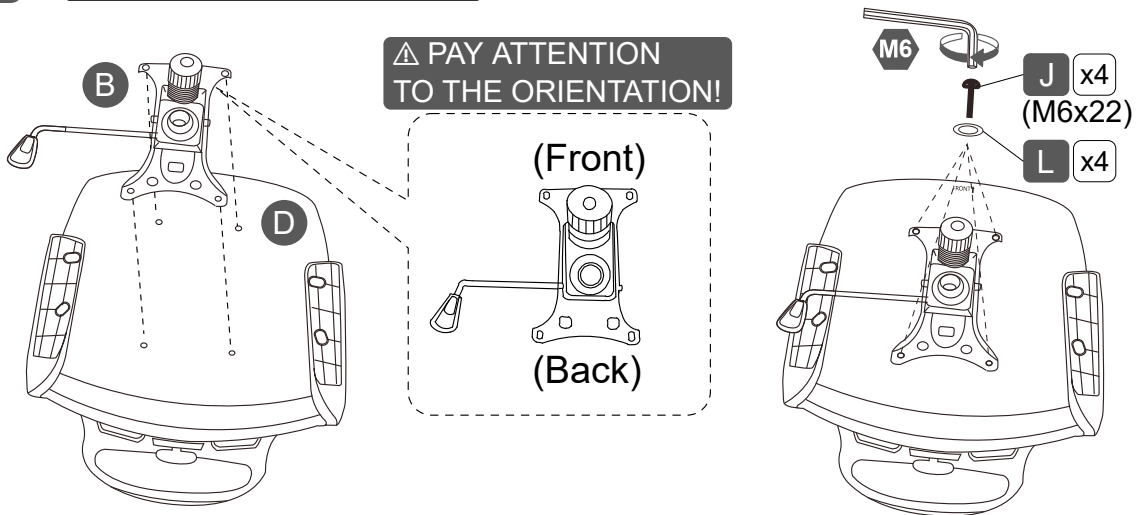

STEP 6 Join the seat with the base.

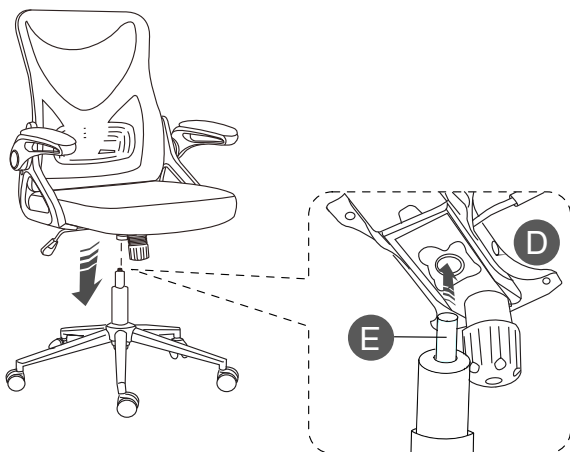

STEP 7 Attach H to A with J and cover with I.

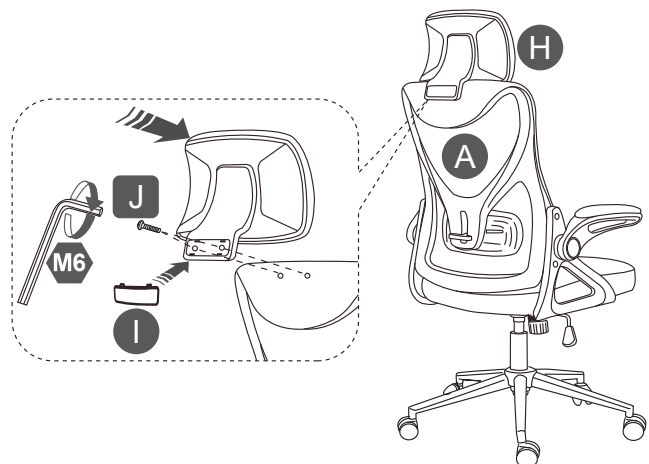

CHAIR'S FUNCTIONS

Move lever UP or DOWN for the lumbar support.

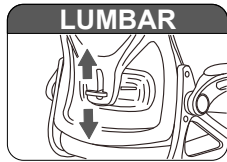

Pull Handle OUT to UNLOCK; Push Handle IN to LOCK.

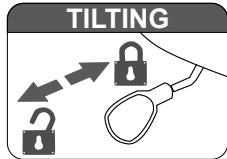

Pull Handle UP.

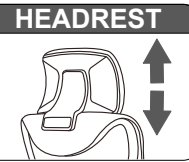
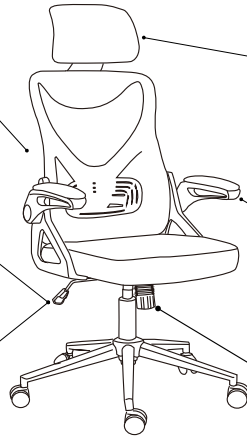
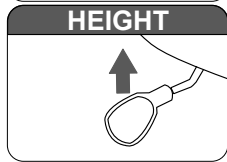

Move headrest UP or DOWN.

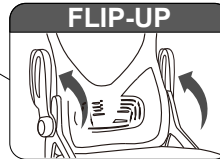

Flip-Up to use as an armless chair.

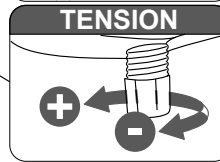

Turn the knob (+) for more tension, and (-) for less tension. Less tensions means easier tilting.

WARNINGS - Not paying attention to the following warnings could result in injuries.

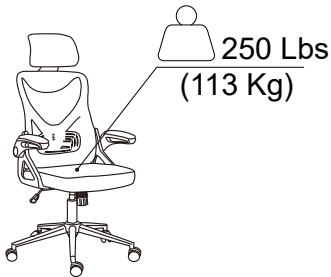

Only one person at a time and refrain from sitting on the edge of the seat to prevent the chair from tipping over.



Do not stand on the chair.

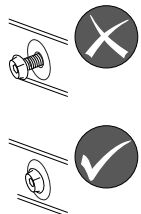

Do not use the chair if the frame parts are damaged, or if any of the screws are loose or missing.



Do not leave babies or toddlers unattended while seated on the chair, always ensure adult supervision. Keep children from playing with the chair for their safety.

CARE AND MAINTENANCE

Clean with a soft cloth lightly dampened in a solution of smooth soap and water.

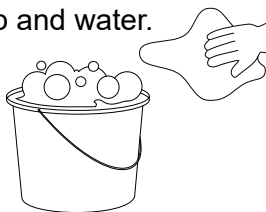

Do not use solvents or abrasive materials.



Do not expose to direct sunlight or to extreme environmental conditions.

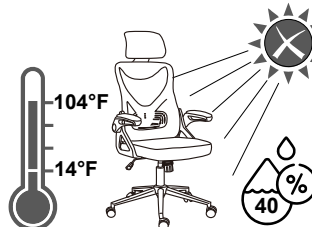

Inspect the chair thoroughly every 4 months and re-tighten the screws.

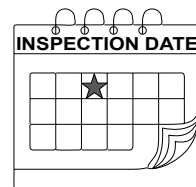

LIMITED WARRANTY



For details, please visit our website: Technimobili.com

To file a claim or request information, please email to: warranty@rtaproducts.com

