





MODEL RTA-9300B

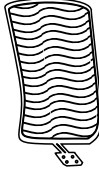

ASSEMBLY INSTRUCTIONS

(REV.2-AFSI-9172-0925)

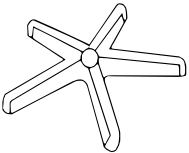
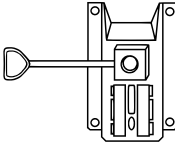

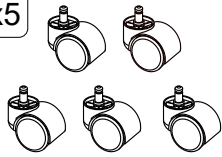
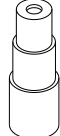
Thank you for purchasing our product!

MAIN PARTS LIST		
A Backrest 	B Seat 	C Nylon star base 
D Mechanism 	E Lift cylinder 	F Casters x5 
G Covers for lift cylinder x1 Set 		

Hardware		
No.	Item	Qty.
H	 M6x25	4
I	 M6x20	4
J	 Washer	4

Included tool	
Allen Wrench	

For support with assembly questions & replacement parts please email us at: support@rtaproducts.com



Free shipping within **the 48 Contiguous United States.**



For international customers & **AK-HI-PR** orders, **the customer is responsible for shipping costs plus any International local taxes or duties.**



technimobili.com



support@rtaproducts.com

ASSEMBLY STEPS

STEP 1

FIRST: Attach F to C.

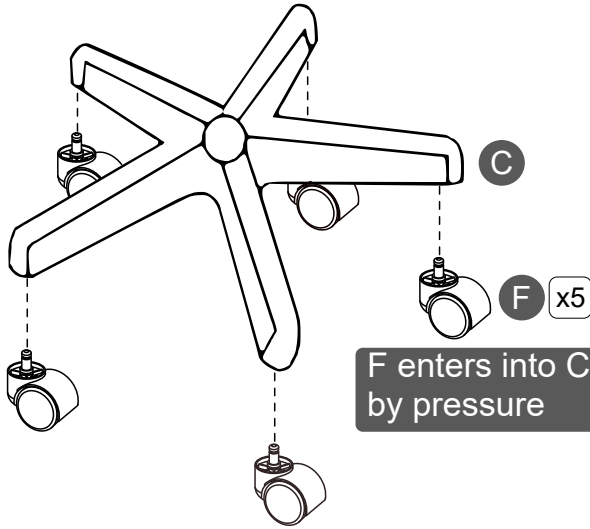

THEN: Place E into C and cover it with G.

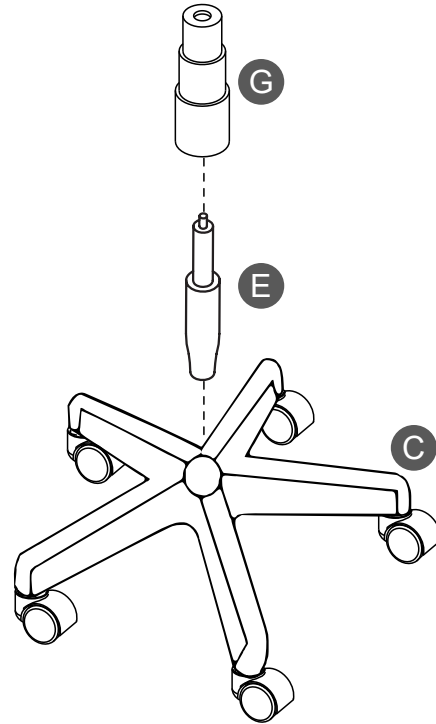

STEP 2

Attach A to B with H.

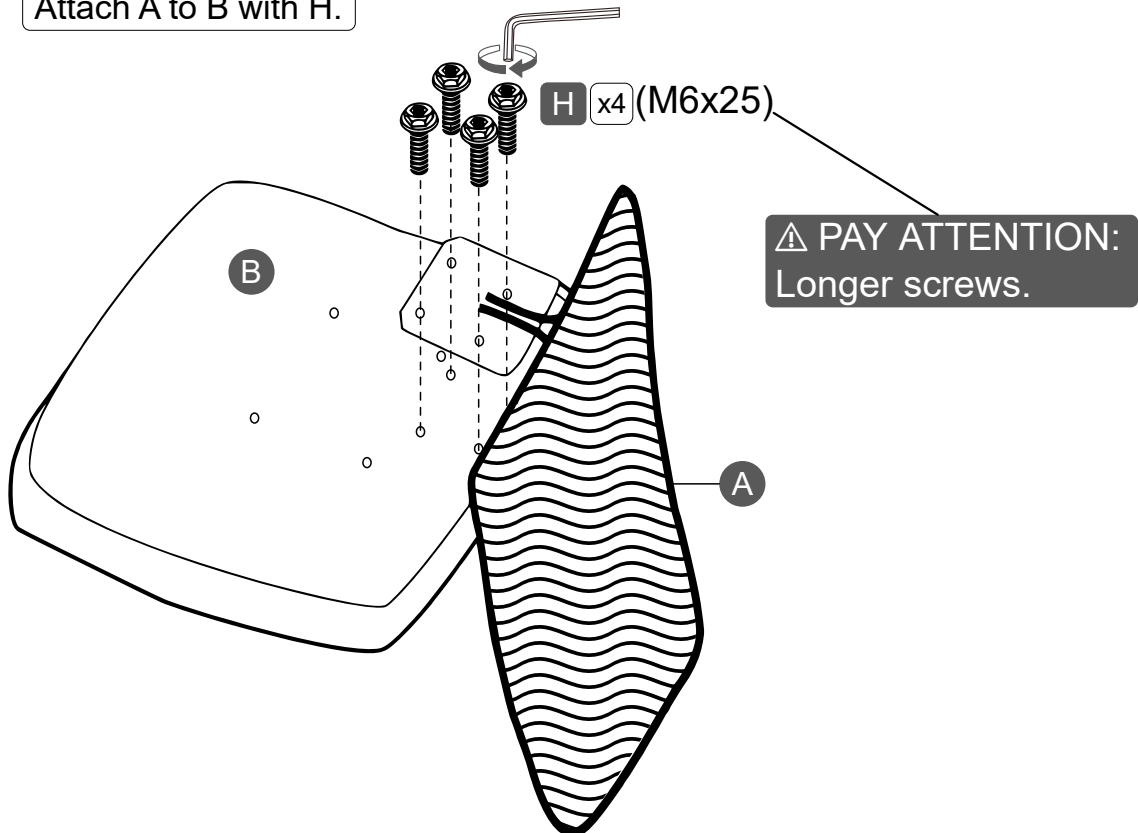

ASSEMBLY STEPS

STEP 3

Attach D to B with I and J.

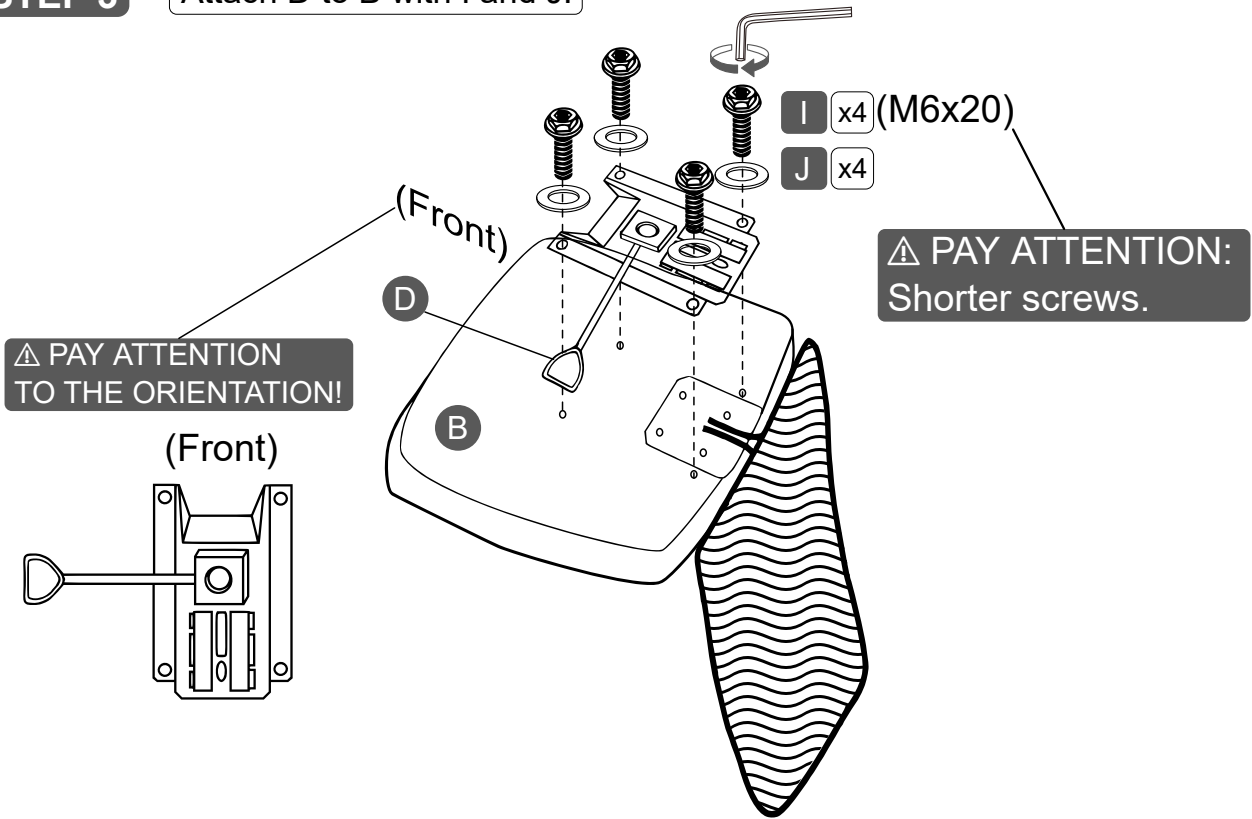

STEP 4

Join the seat with the base.

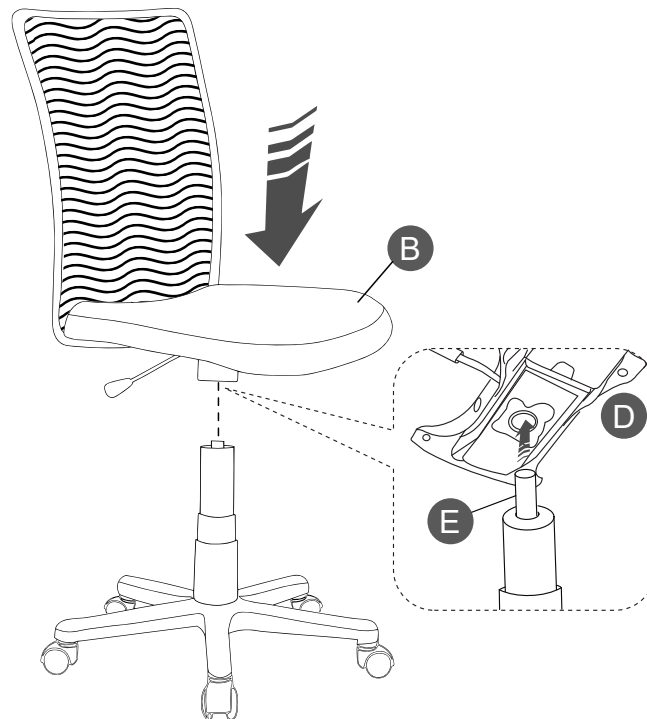

CHAIR'S FUNCTIONS

Pull Handle UP.



WARNINGS - Not paying attention to the following warnings could result in injuries.

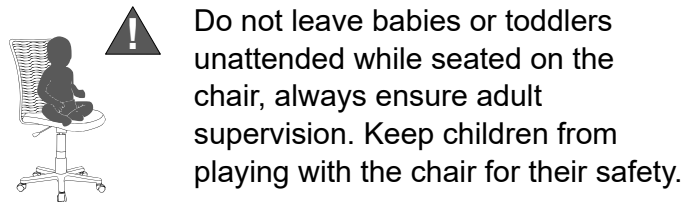
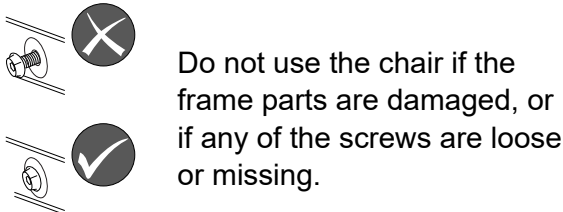
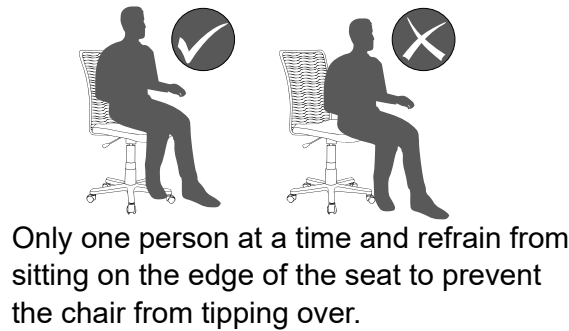
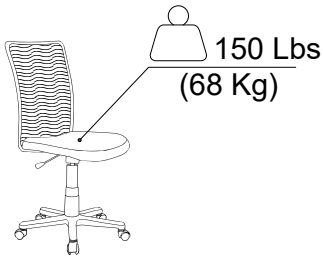

CARE AND MAINTENANCE

Clean with a soft cloth lightly dampened in a solution of smooth soap and water.

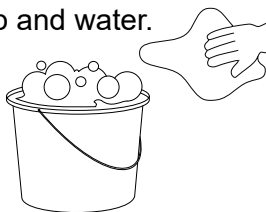

Do not use solvents or abrasive materials.



Do not expose to direct sunlight or to extreme environmental conditions.

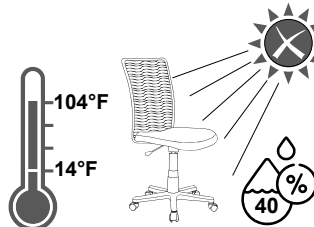

Inspect the chair thoroughly every 4 months and re-tighten the screws.

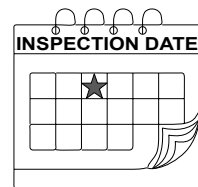

LIMITED WARRANTY



For details, please visit our website:
Technimobili.com

To file a claim or request information, please email to:
warranty@rtaproducts.com

