

Modern Tufted Office Chair with Arms

**MODEL RTA-2024**





**ASSEMBLY INSTRUCTIONS**



REV.2-BZ-8744-0225

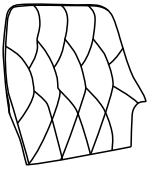

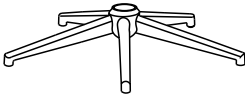
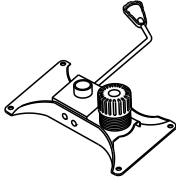
Thank you for purchasing our product!

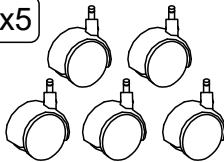
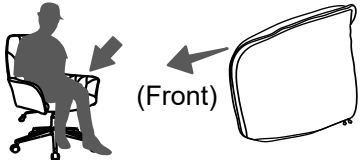
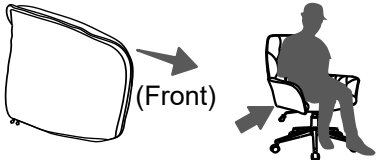
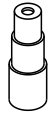
<p>Do a quick inventory of all the parts and hardware listed below.</p> 	<p><b>For Support, assembly questions &amp; Replacement Parts within the 48 Contiguous United States:</b></p> <p>Please email us at: <a href="mailto:support@rtaproducts.com">support@rtaproducts.com</a></p> 	<p>Replacement Parts for International Customers &amp; <b>AK-HI-PR</b> orders: RTA Products will replace the part free of charge, while <b>the customer is responsible for shipping costs plus any International local taxes or duties.</b></p>
---	---	---

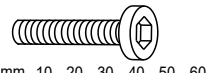
MAIN PARTS LIST				
<p><b>A</b> Backrest</p> 	<p><b>B</b> Seat</p> 	<p><b>C</b> 5-Leg star base</p> 	<p><b>D</b> Mechanism</p> 	<p><b>E</b> Lift cylinder</p> 
<p><b>F</b> Casters</p> <p>x5</p> 	<p><b>G-L</b> Left armrest</p>  <p>(Front)</p>	<p><b>G-R</b> Right armrest</p>  <p>(Front)</p>	<p><b>H</b> Covers for lift cylinder</p> <p>x1 Set</p> 	

HARDWARE LIST			
Part #	QTY	SIZE/Description	Item
I	4	M6x20	
J	8	M8x35	
K	8	Ø22, Ø8, 2mm	

INCLUDED TOOLS	
Allen Wrench	

## ASSEMBLY STEPS

### STEP 1

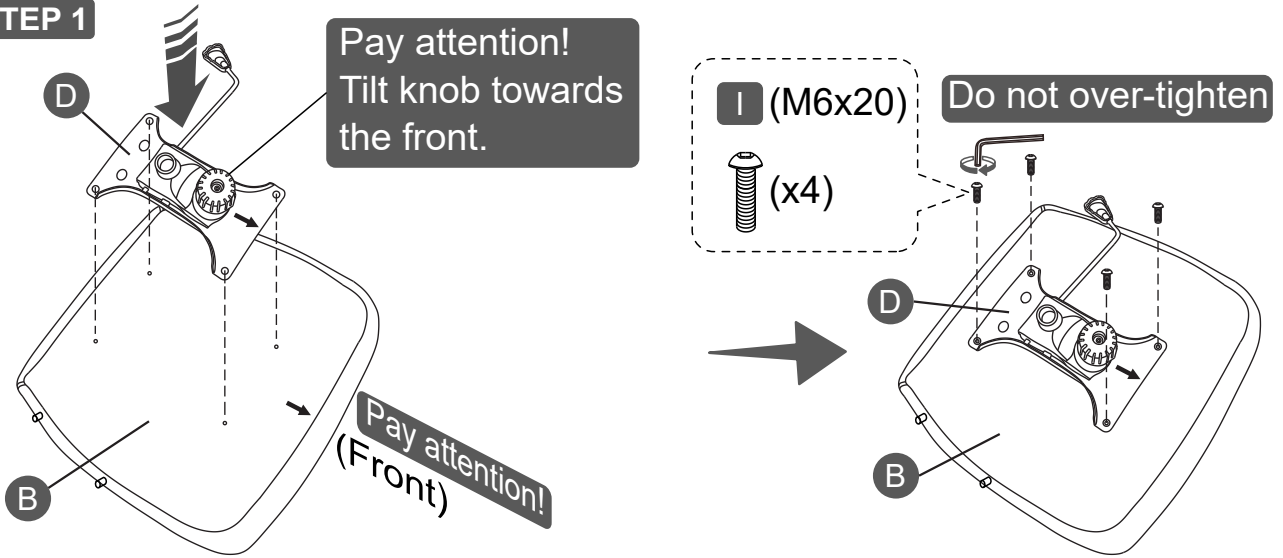

### STEP 2

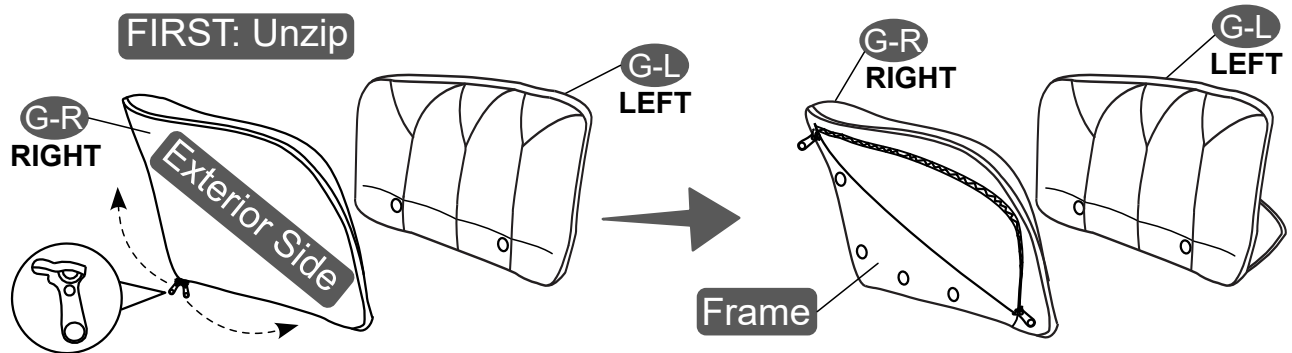

**THEN: Attach G-L and G-R to B on their respective sides.**

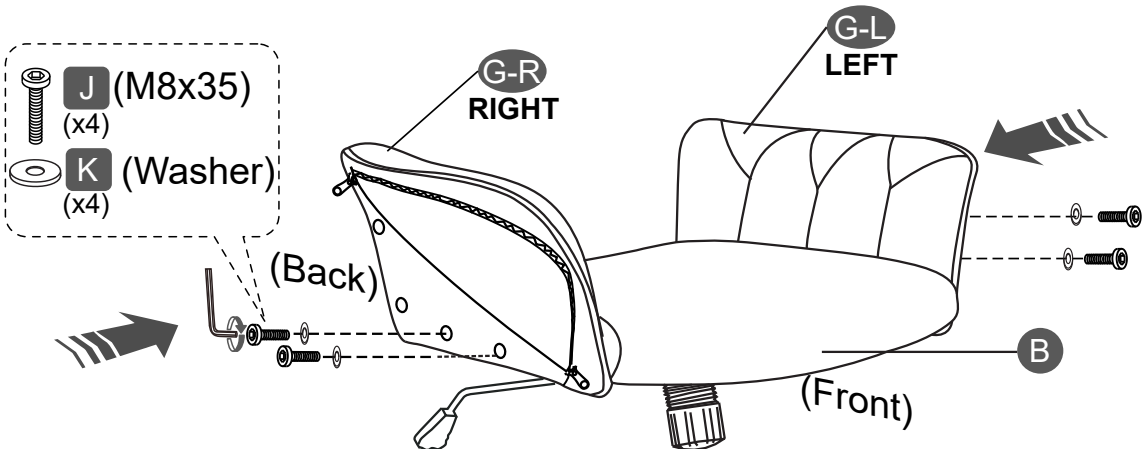

ASSEMBLY STEPS

STEP 3

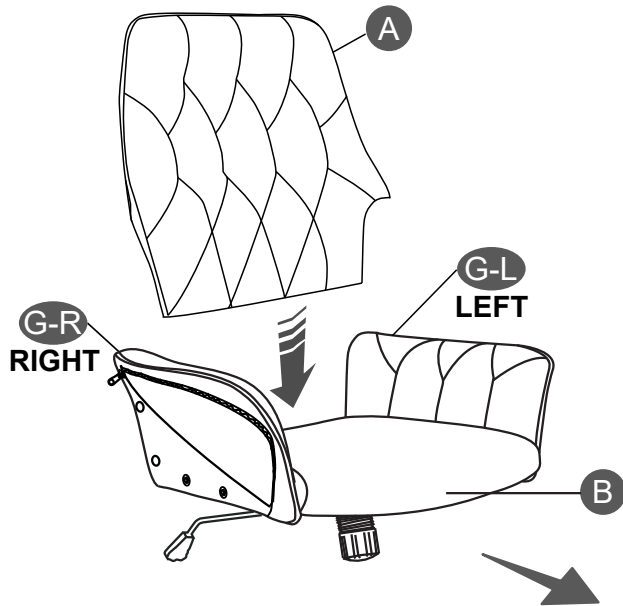

**Pay attention!**  
To make sure the holes from A will align well with the holes on G-L and G-R, the bottom screws should be loosened to allow flexibility.

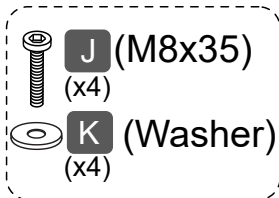

After attaching A, proceed to tighten all the screws and fasten the zippers.

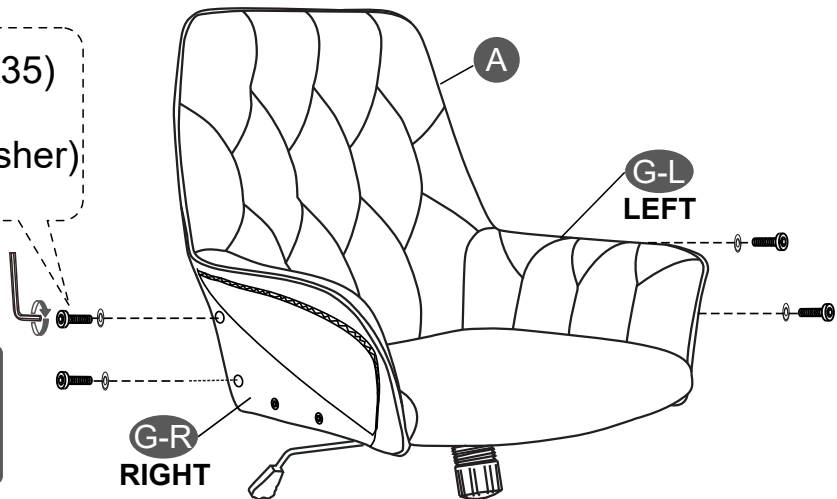

STEP 4

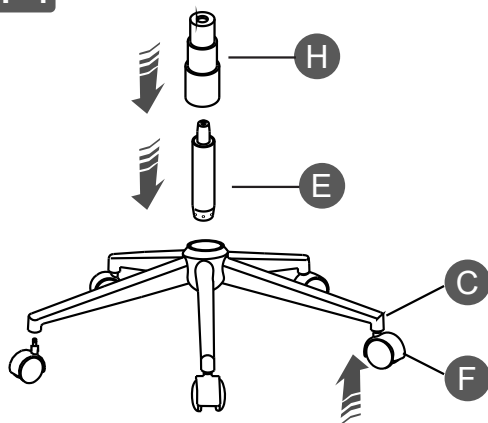

F will enter into C by applying pressure.

STEP 5

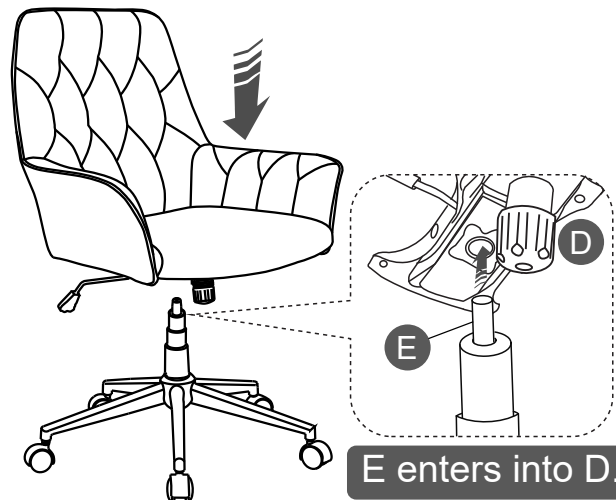

E enters into D.

## CHAIR'S FUNCTIONS

Pull Handle UP.

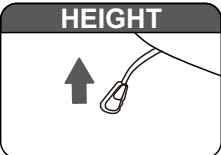

Pull Handle OUT to UNLOCK; Push Handle IN to LOCK.

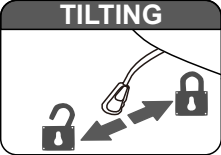



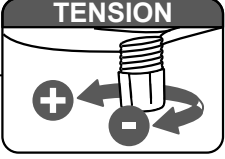

**TENSION**



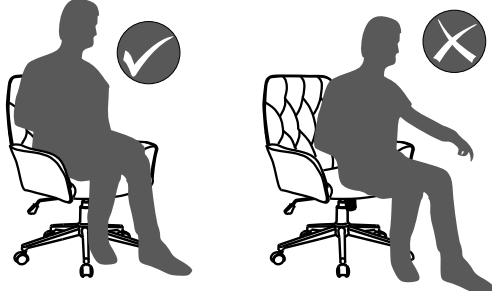
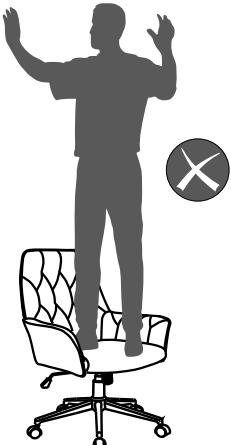
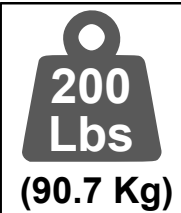

Turn **CLOCKWISE** for less tension (-); **COUNTERCLOCKWISE** for more tension (+).  
With less tension, the tilting feels easier.

## WARNINGS - Not paying attention to the following warnings could result in injuries.

 <p>Do not use the chair if the frame parts are damaged, or if any of the screws are loose or missing.</p>	 <p>Only one person at a time and refrain from sitting on the edge of the seat to prevent the chair from tipping over.</p>	 <p>Do not stand or use the chair as ladder.</p>
<p><b>WEIGHT LIMIT DO NOT EXCEED</b></p>  <p><b>200 Lbs (90.7 Kg)</b></p>	 <p>Do not leave babies or toddlers unattended while seated on the chair, always ensure adult supervision. Keep children from playing with the chair for their safety.</p>	

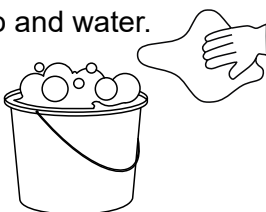
## CARE AND MAINTENANCE

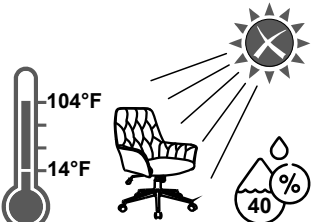
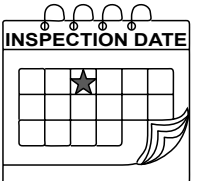
<p>Clean with a soft cloth lightly damped in a solution of smooth soap and water.</p> 	<p>Do not use solvents or abrasive materials.</p> 	<p>Do not expose to direct sunlight or to extreme environmental conditions.</p> 	<p>Inspect the chair thoroughly every 4 months and re-tighten the screws.</p> 
---	---	--	---

## WARRANTY



LIMITED 2 YEAR WARRANTY

For details on the Warranty Policy, please visit online:  
[www.technimobili.com](http://www.technimobili.com)