





MODEL RTA-KS40

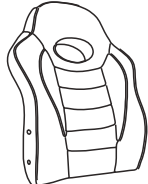

ASSEMBLY INSTRUCTIONS

REV.2-WT-9375-1225

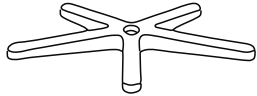
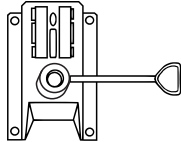

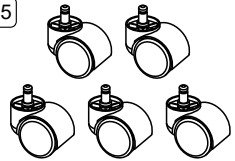
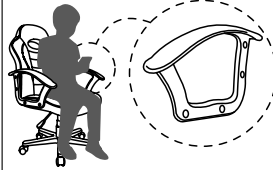
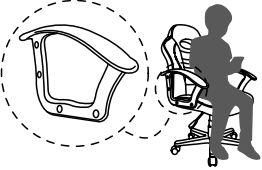
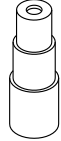
Thank you for purchasing our product!

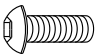
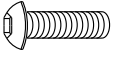
MAIN PARTS LIST		
A Backrest 	B Seat 	C Nylon star base 
D Mechanism 	E Lift cylinder 	F Casters x5 
G-L Left armrest 	G-R Right armrest 	H Covers for lift cylinder x1 Set 

Hardware			
No.	Item		Qty.
I	M6x20		4
J	M6x25		8
K	Metal washer		4
L	Hole caps		8

Tools (Included)	
Allen Wrench	M5 



For support with assembly questions & replacement parts please email us at:
support@rtaproducts.com
Free shipping within the 48 Contiguous United States.



For international customers & **AK-HI-PR** orders, **the customer is responsible for shipping costs plus any International local taxes or duties.**

ASSEMBLY STEPS

STEP 1

1st: Install F into C using pressure.

F enters into C by pressure

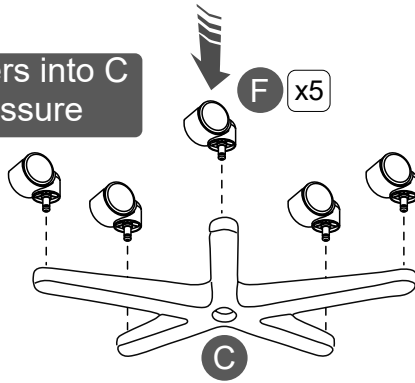

2nd: Place E into C and cover it with H.

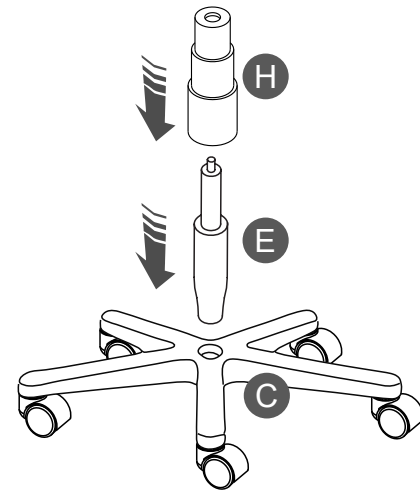

STEP 2

Use I and K to attach D to B as indicated.

⚠ PAY ATTENTION TO THE ORIENTATION!

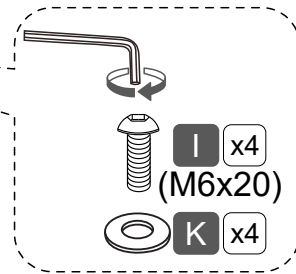
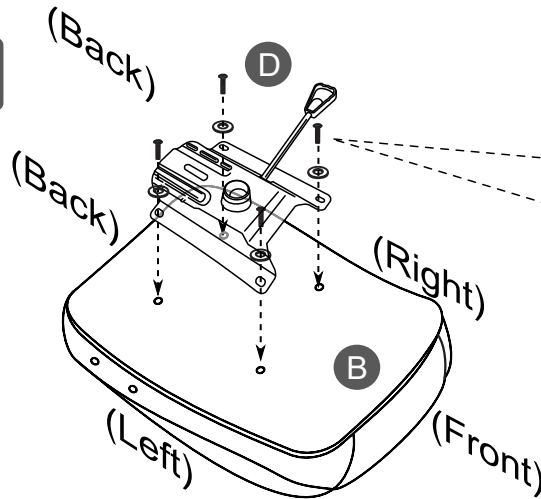
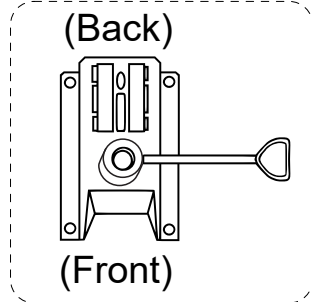

STEP 3

Join the seat to the base pieces.

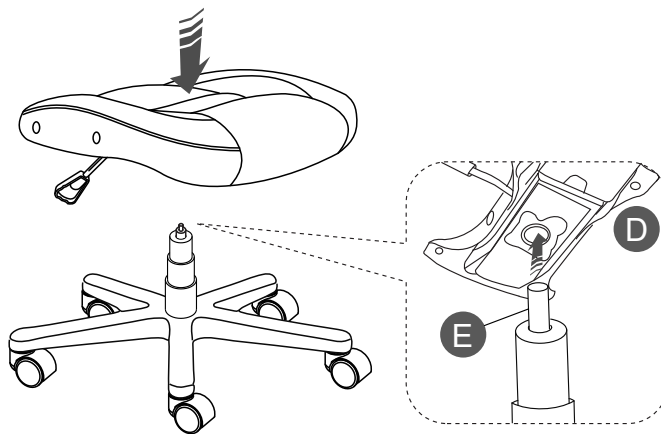

ASSEMBLY STEPS

STEP 4

Use J to attach G-L and G-R to B on their respective sides.

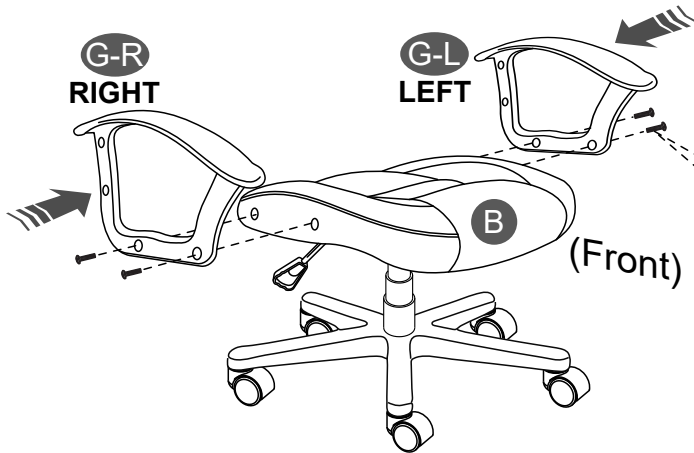

⚠ PAY ATTENTION:
Leave the screws loose to allow flexibility for the next step.

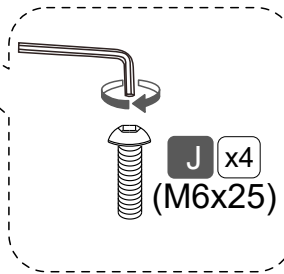

STEP 5

1st: Use J to attach A to G-L and G-R.

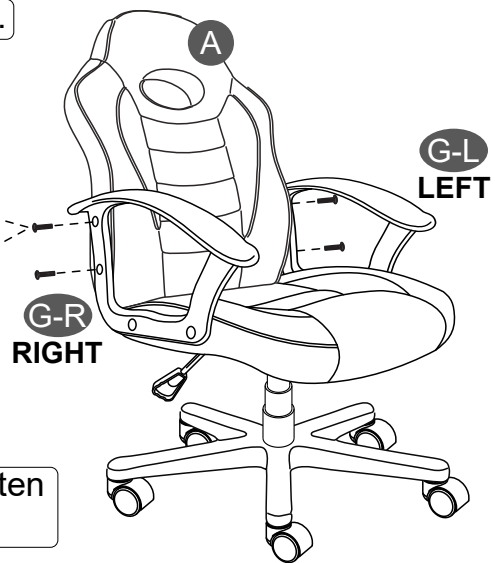
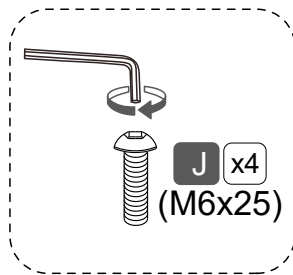
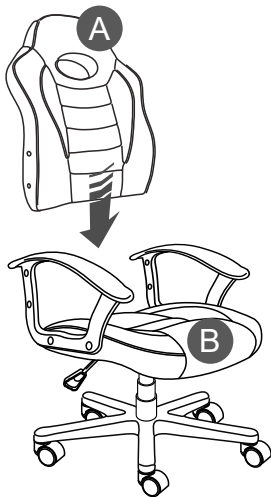

2nd: Proceed to tighten all the screws.

STEP 6

FINALLY, cover the screw holes with L.

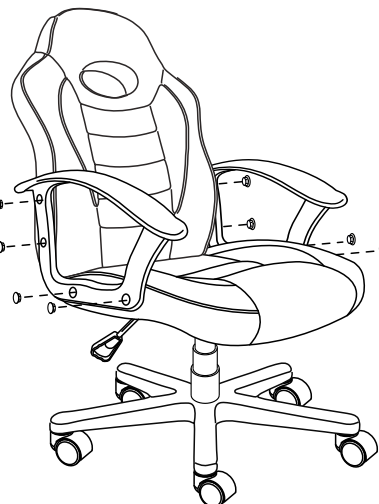
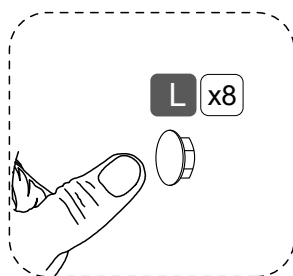

CHAIR'S FUNCTIONS

Pull Handle UP.

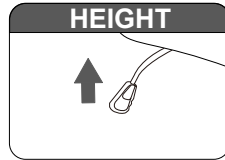

WARNINGS - Not paying attention to the following warnings could result in injuries.

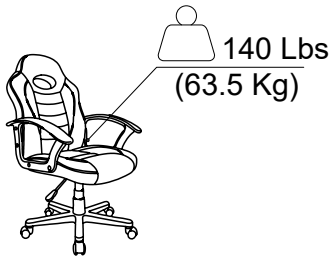

Only one person at a time and refrain from sitting on the edge of the seat to prevent the chair from tipping over.



Do not stand on the chair.

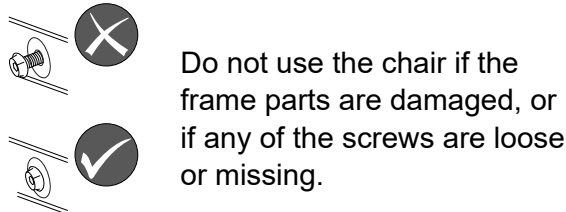

Do not use the chair if the frame parts are damaged, or if any of the screws are loose or missing.

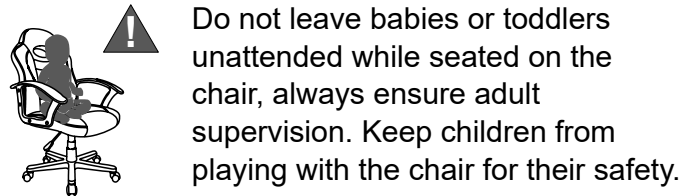

Do not leave babies or toddlers unattended while seated on the chair, always ensure adult supervision. Keep children from playing with the chair for their safety.

CARE AND MAINTENANCE

Clean with a soft cloth lightly dampened in a solution of smooth soap and water.

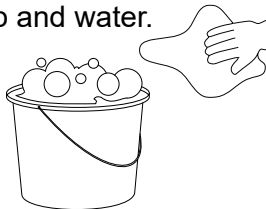

Do not use solvents or abrasive materials.



Do not expose to direct sunlight or to extreme environmental conditions.

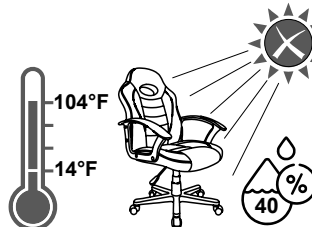

Inspect the unit thoroughly every 4 months and re-tighten the screws.

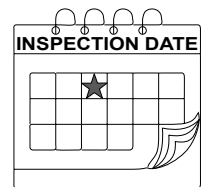

LIMITED WARRANTY



For details, please visit our website: Technimobili.com

To file a claim or request information, please email to: warranty@rtaproducts.com

