

MODEL RTA-8030

ASSEMBLY INSTRUCTIONS

REV.5-BOL-9296-1125



Thank you for purchasing our product!





Hardware			
Part #	QTY	SIZE/Description	Item
H	4	M6x20	
I	2	M6x25	
J	4	Hole cover	

Tools (Included)	
Allen Wrench	

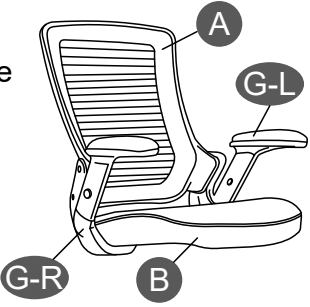
MAIN PARTS LIST

***** For your convenience, the pieces A, B, G-L and G-R (Backrest, seat and armrests) come pre-assembled; if there is damage to any of those pieces, they can be replaced by just removing the screws that hold them together, there is no need to replace the whole unit.

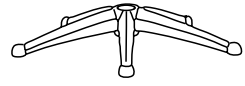
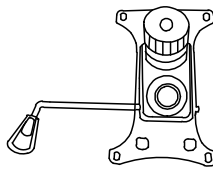

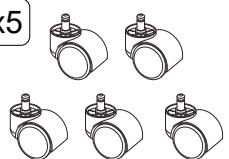
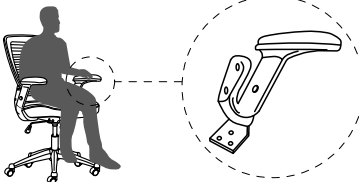
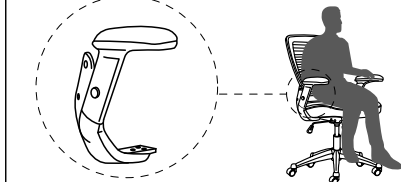
A * Backrest 	B * Seat 	C Nylon star base 
D Mechanism 	E Lift cylinder 	F Casters x5 
G-L * Left armrest 		G-R * Right armrest 

For support with assembly questions & replacement parts please email us at: support@rtaproducts.com



Free shipping within **the 48 Contiguous United States.**



For international customers & **AK-HI-PR** orders, **the customer is responsible for shipping costs plus any International local taxes or duties.**



technimobili.com



support@rtaproducts.com

ASSEMBLY STEPS

STEP 1

FIRST: Attach F to C.

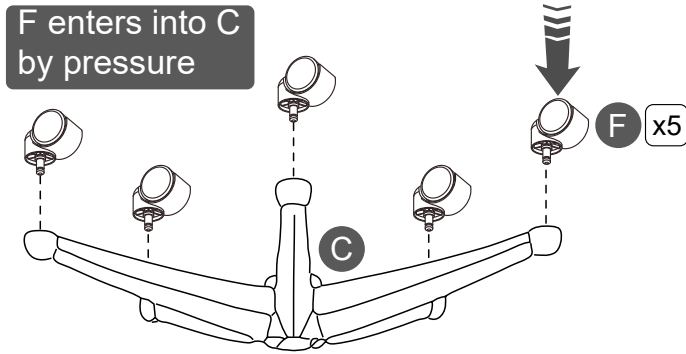

THEN: Insert E into C.

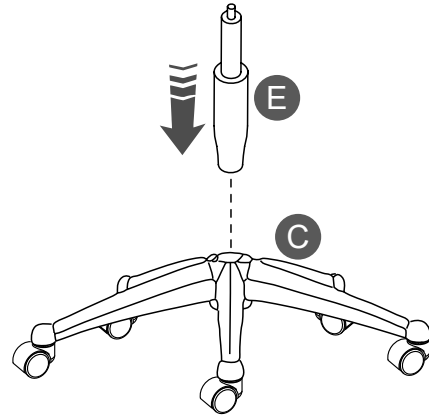

STEP 2

Use H to attach D to B.

⚠ PAY ATTENTION TO THE ORIENTATION!

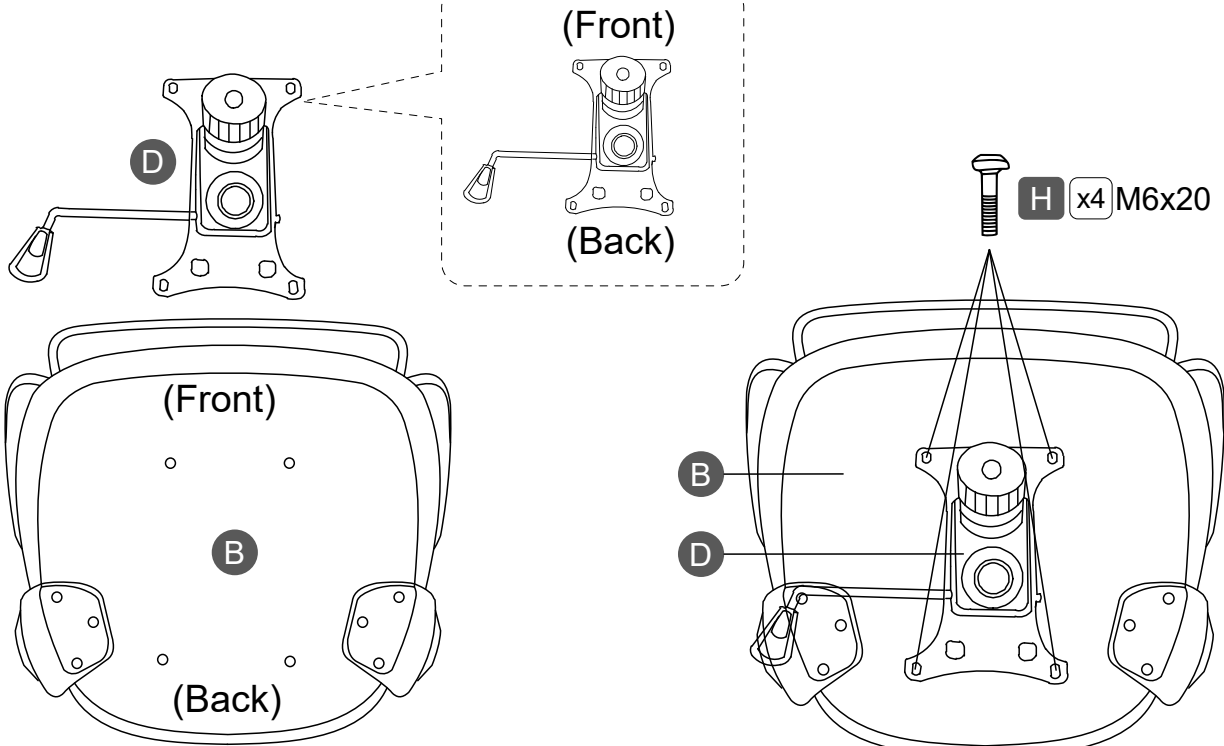

ASSEMBLY STEPS

STEP 3

Join the seat to the base parts and unflod the backrest A.

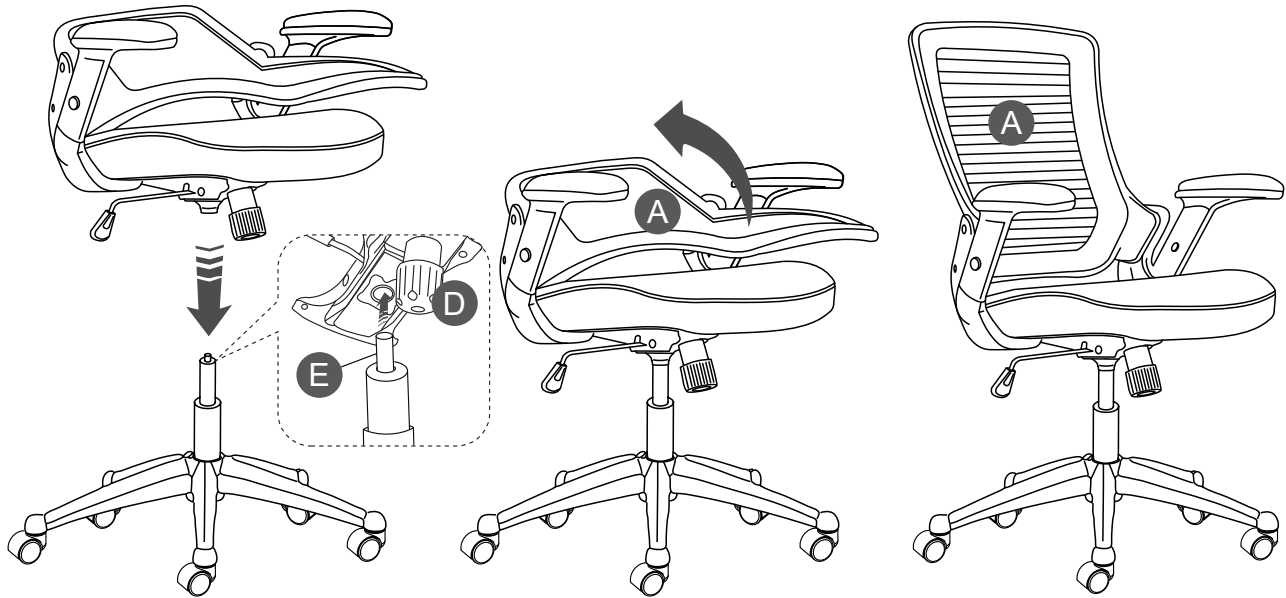

STEP 4

FIRST: Use I to secure the backrest A to the armrests G-L and G-R.

FINALLY: Use J to cover the screwholes on the armrests.

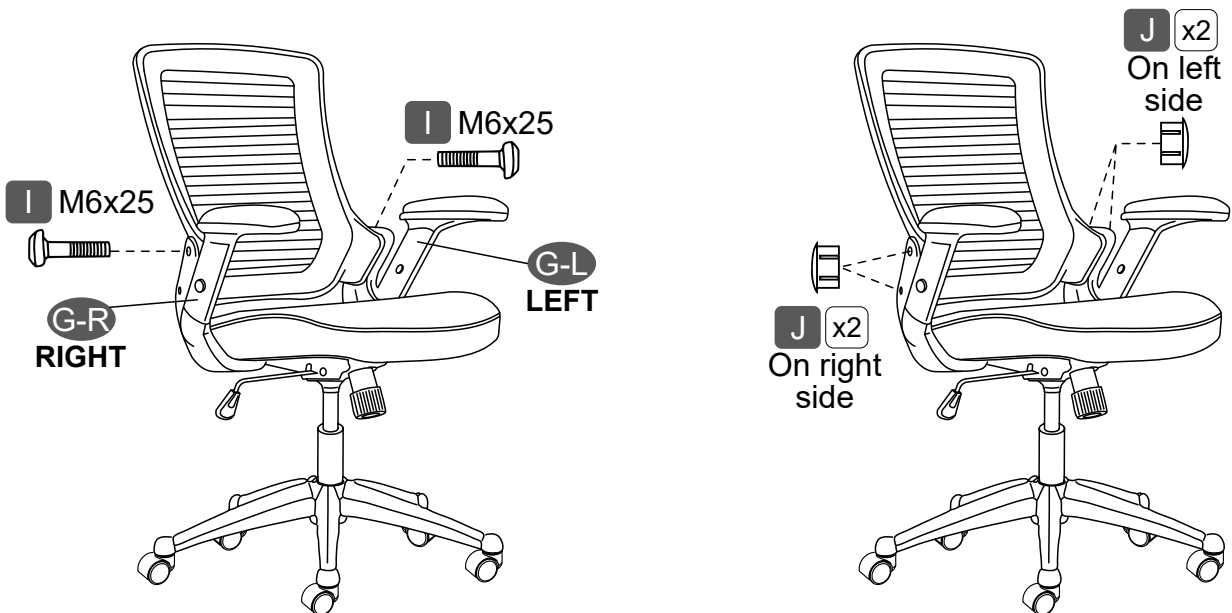

CHAIR'S FUNCTIONS

Pull Handle OUT to UNLOCK;
Push Handle IN to LOCK.

Pull Handle UP.

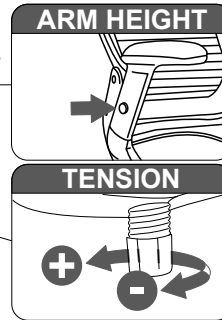
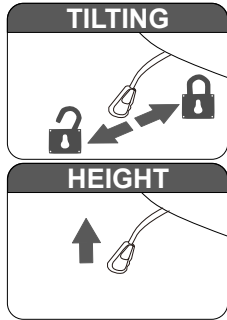

Turn the knob (+) for more tension, and (-) for less tension. Less tensions means easier tilting.

WARNINGS - Not paying attention to the following warnings could result in injuries.

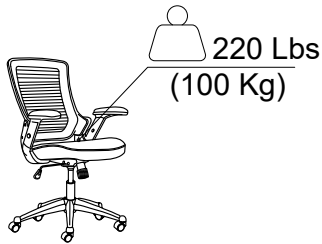

220 Lbs
(100 Kg)



Only one person at a time and refrain from sitting on the edge of the seat to prevent the chair from tipping over.

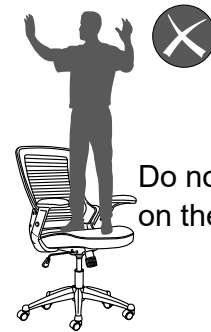

Do not stand on the chair.

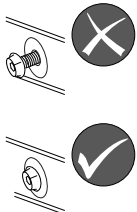

Do not use the chair if the frame parts are damaged, or if any of the screws are loose or missing.



Do not leave babies or toddlers unattended while seated on the chair, always ensure adult supervision. Keep children from playing with the chair for their safety.

CARE AND MAINTENANCE

Clean with a soft cloth lightly dampened in a solution of smooth soap and water.

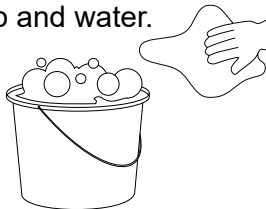

Do not use solvents or abrasive materials.



Do not expose to direct sunlight or to extreme environmental conditions.

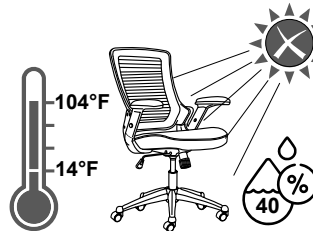

Inspect the chair thoroughly every 4 months and re-tighten the screws.

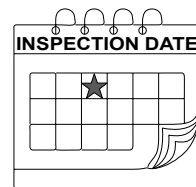

LIMITED WARRANTY



For details, please visit our website:
Technimobili.com

To file a claim or request information, please email to:
warranty@rtaproducts.com

