

THIS INSTRUCTION BOOKLET CONTAINS  
**IMPORANT** SAFETY INFORMATION. PLEASE  
READ AND KEEP FOR FUTURE REFERENCE.

Lot Number: \_\_\_\_\_

Date: \_\_\_\_\_

For factory use only

# TV Stand

PART NO: 63607103

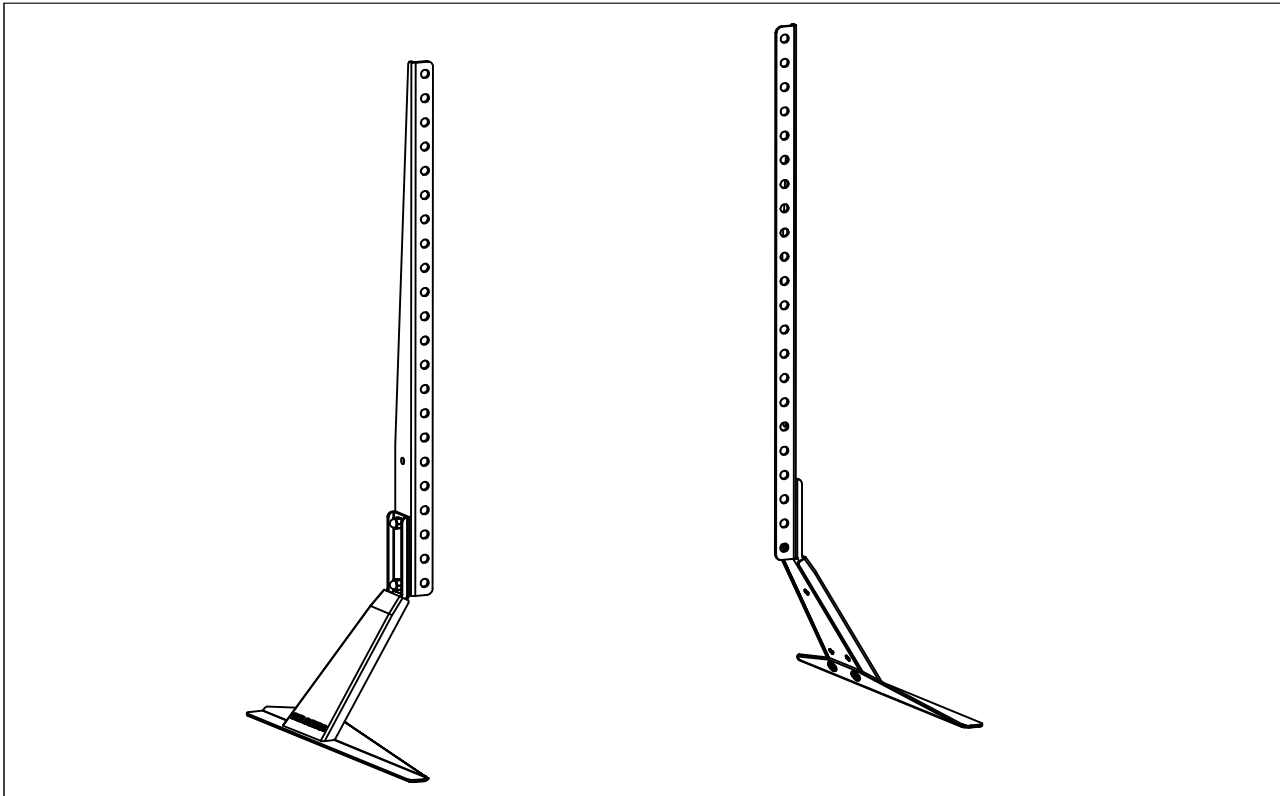

Congratulations on your latest Atlantic purchase. Follow these simple instructions and you'll have your TV Stand assembled in no time.

Maximum TV loading weight up to 66 lbs (30 kgs).  
This TV Stand fits up to a 600mm x 600mm VESA hole pattern.

Keep this Instruction Manual for future reference.  
Keep your original proof of purchase (store receipt).



If you have any questions and/or wish to order parts, please call us toll free at [800-747-2660](tel:800-747-2660), or email [customer\\_relations@atlantic-inc.com](mailto:customer_relations@atlantic-inc.com).

# Assembly Tips:

Become familiar with the instructions and all parts. Select the best assembly option that fits your TV properly.

Make sure that all parts are in the box and in good condition.

Assemble the product on the open flat carton or a rug to protect the product and floor.

Some heavy products need a second person to assist with the assembly.

Do not install on a sloping surface.

With each step, first insert and hand-tighten all bolts and screws. After **ALL BOLTS** are slightly screwed in, fully tighten bolts or screws with a screwdriver.

You may want to secure your TV to prevent it tipping.



## Caution:

If you do not understand these instructions, or have doubts about the safety of this installation, contact customer service or call a qualified contractor. The manufacturer is not liable for damage or injury caused by incorrect mounting, assembly or use.

Never let children climb on product or play with product.





Do not sit or stand on the product.

Do not install a TV that is heavier than the maximum 66 lbs (30 kg) load rating.



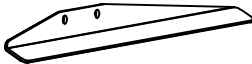

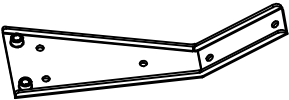

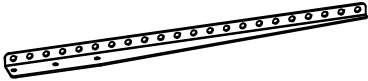
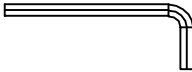
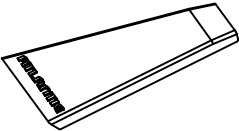





Improper handling can result in cuts and lacerations.

Images are for reference only.

## Parts List

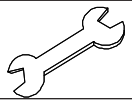
Part #	Item	Qty	Part #	Item	Qty
A		2	E	 M6X10 mm	8
B		2	F		4
C		2	G		1
D		2			

# Hardware List

Part #	Item	Qty	Part #	Item	Qty
I	 M8X16 mm	4	Q	 M4/M5 washer	4
J	 M6X12 mm	4	R	 M6/M8 washer	4
K	 M5X12 mm	4	S	 Big spacer	4
L	 M4X12 mm	4	T	 Small spacer	4
M	 M8X40 mm	4	U		1
N	 M6X35 mm	4			
O	 M5X30 mm	4			
P	 M4X30 mm	4			

Attach the foot (A) to part (B) with screws (E) using wrench (G). Repeat for second assembly.

**1**

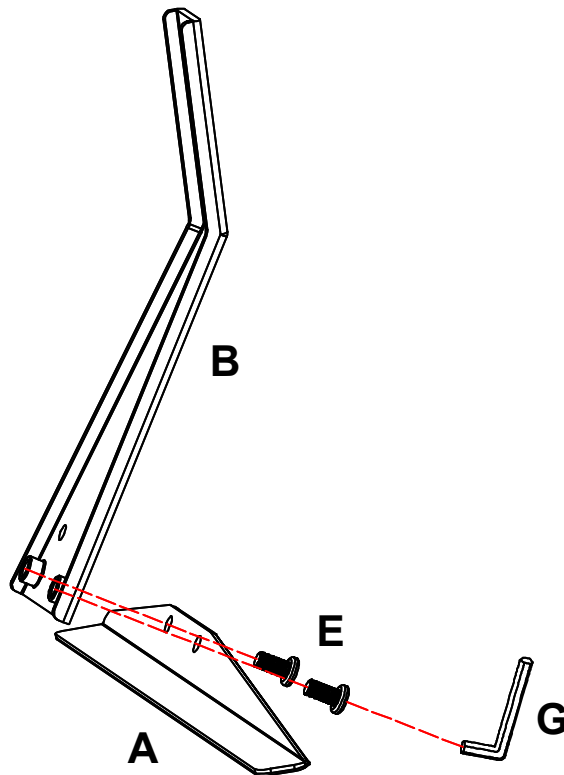

Attach part (C) to part (B) with screws (E) and nuts (F) using wrenches (U and G). Repeat for second assembly.

**2**

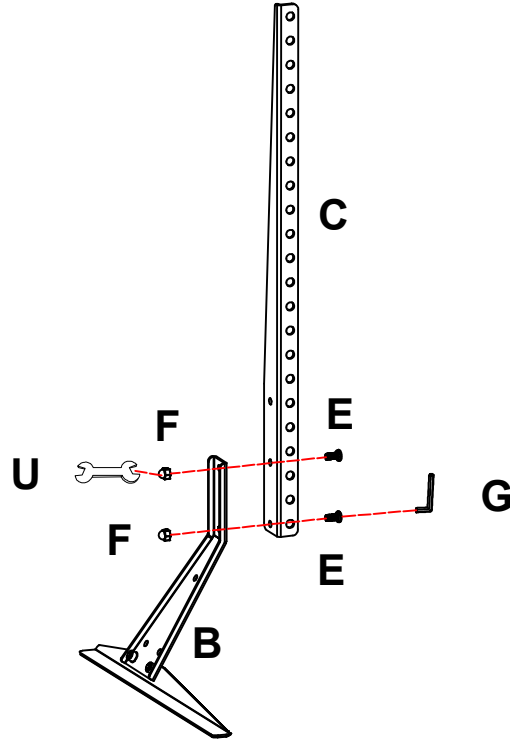

Attach the cover (D) to part (B). Repeat for second assembly.

**3**

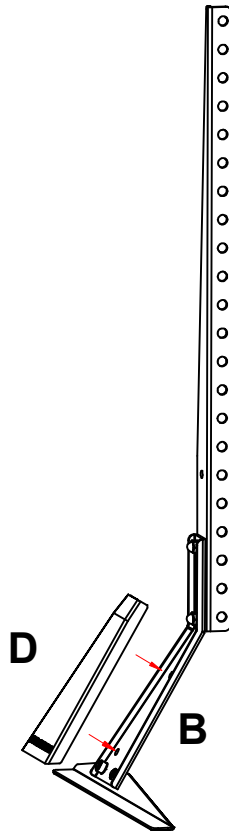

Carefully lay your TV face down on a flat non-abrasive surface, laying padding underneath it to protect the screen. Attach the TV Stand to the back of your TV, using the supplied mounting hardware, based upon the screw hole size on your TV.

4

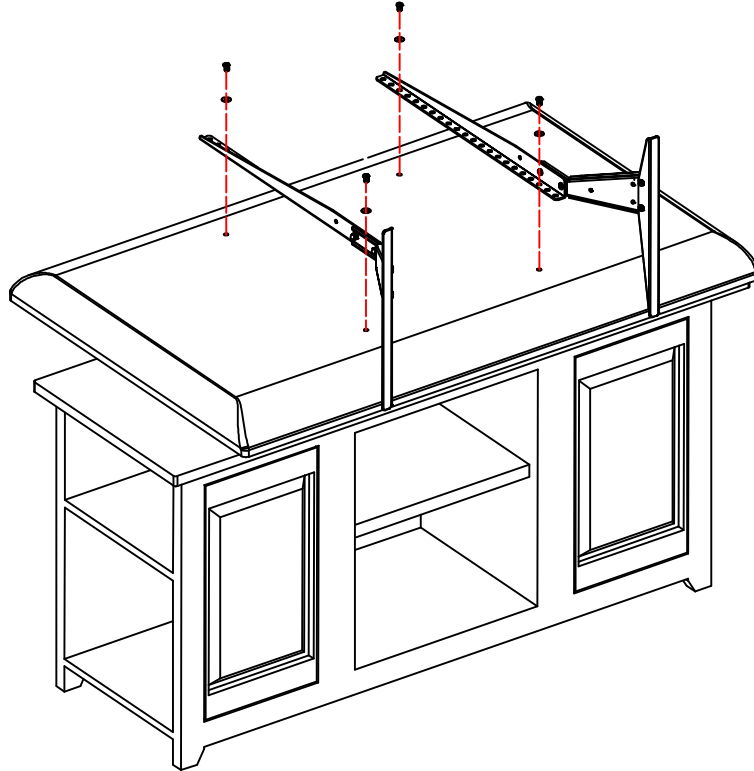

Position the TV on top of your existing TV Cabinet.

OK

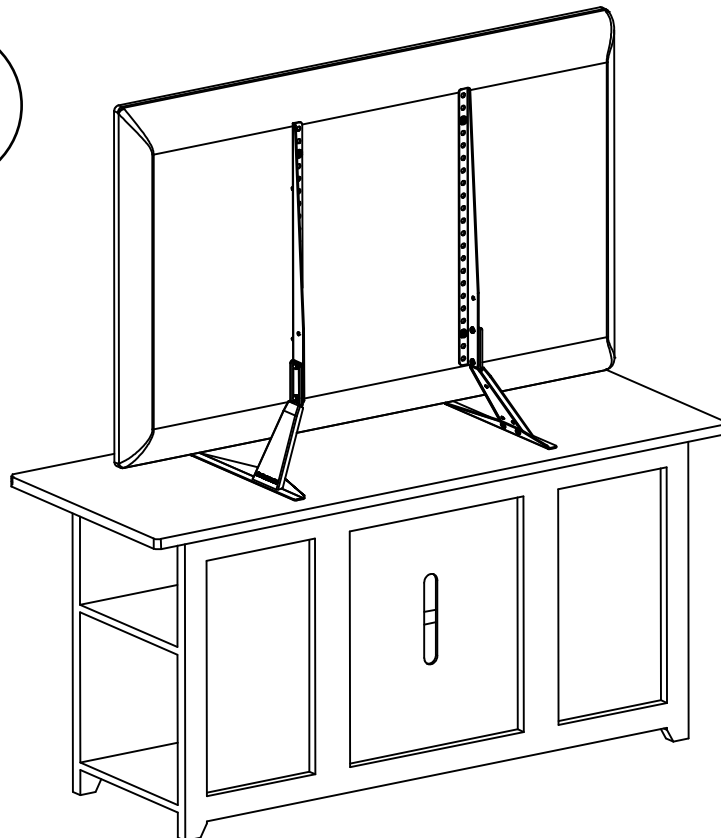

**Product Warranty:** Atlantic Inc., warrants to the original purchaser that its products are free from defect in materials and workmanship. If after inspection, we find that the product was defective in materials or workmanship we shall repair or replace the product at our discretion. This warranty does not cover accidental damage, misuse, improper care or alteration and excludes claims for incidental or consequential loss. This limited warranty applies to product purchased in the U.S. and Canada. This warranty gives you specific legal rights and you may also have other rights which vary from State to State. The warranty duration is one year from the date of purchase.

**ATLANTIC®**

© 2013 Atlantic Inc. Santa Fe Springs, CA. U.S.A.  
U.S. and other foreign patents pending /  
Patentes de los EUA y países extranjeros en trámite /  
Brevets en cours pour les États-Unis et autres pays

All rights reserved / Derechos Reservados /  
Tous droits réservés

Made in China / Hecho en China /  
Fabriqué en Chine

[www.atlantic-inc.com](http://www.atlantic-inc.com)

R1.0 130405 #63607103