















Assembly Instructions / Directives d'assemblage / Instrucciones:

Qty Cant. / Qté	Parts List Lista de Componentes / Liste des pieces:
1	 A
1	 B
8	 C
1	 D
4	 E
4	 F
4	 G
1	 H
4	 I
4	 J
4	 K

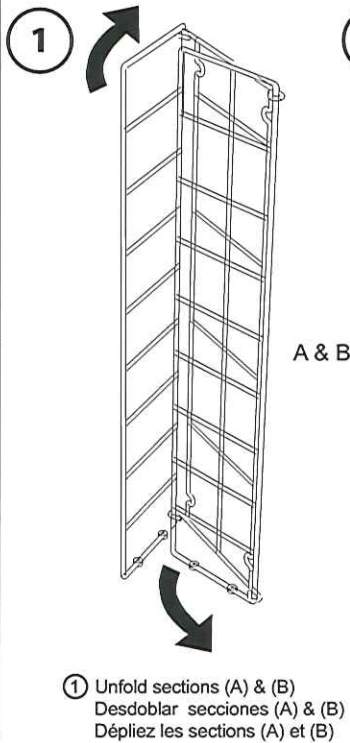

Tools needed / not included
Outils requis / non fournis
Herramientas requeridas / no incluidas

 
Phillips screwdriver
Tournevis Phillips
Desarmador de cruz (Phillips)

 
wrench
llave inglesa
clé plate

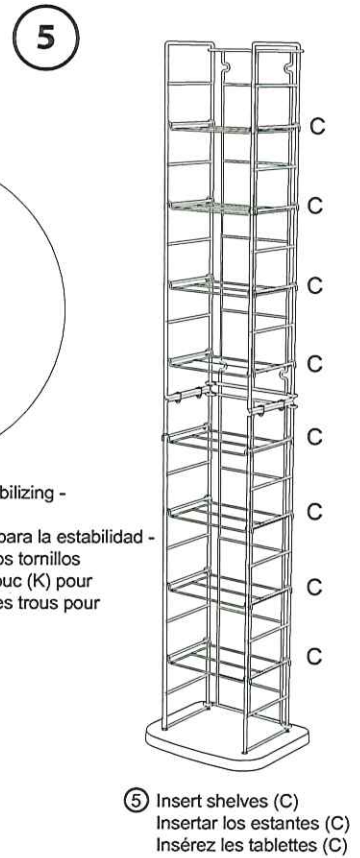
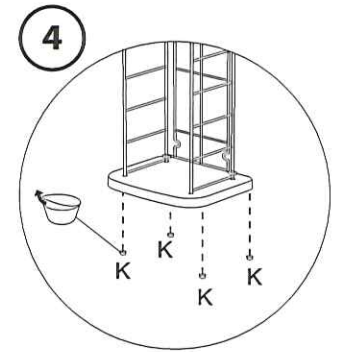
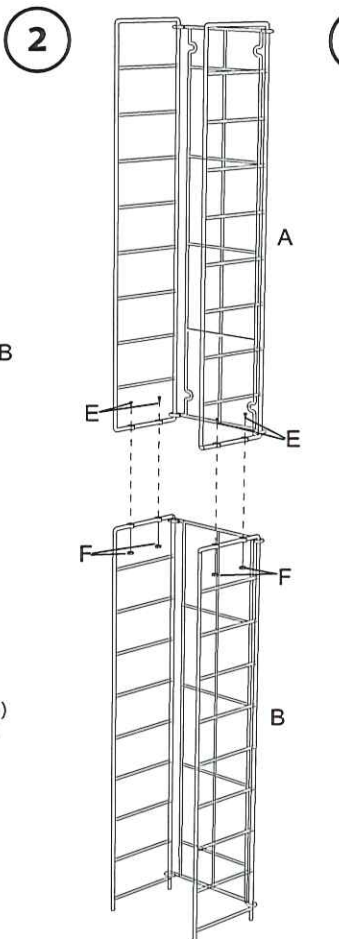

Add "Atlantic" Legalese
↓
ATLANTIC
2009 Atlantic Inc, South
...

Or / O / Ou

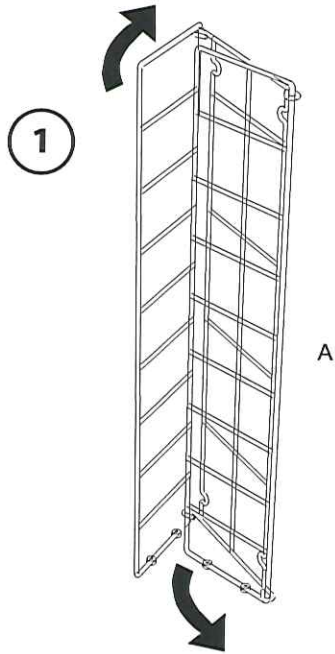

- ① Unfold sections (A)
Desdoblar secciones (A)
Dépliez les sections (A)



- ② Place unit at desired position.
Colocar la unidad en el lugar deseado.
Placez l'unité dans la position désirée.

Mark hole position on the wall with pencil.
Marque la posición de la perforación en la pared con lapiz.
Faites une marque avec votre crayon pour indiquer où vous percerez le trou.

Drill a hole on the pencil mark on the wall. Insert the plastic anchor (I) into the wall.
Haga una perforación en la pared en la marca hecha con lapiz.
Inserte el taquete de plástico (I) en la pared.
Percez un trou à l'endroit indiqué sur le mur. Insérez le dispositif d'ancrage (I) dans le mur.

Place unit back against the wall.
Poner el respaldar de la unidad contra la pared.
Placez le dos de l'unité contre le mur.

Screw
Screw the dry-wall (J) into the wall anchor (I)
Atornille el tornillo para cartón de yeso (J) en el taquete de pared (I).
Serrez la vis pour cloison sèche (J) dans le dispositif d'ancrage mural (I).

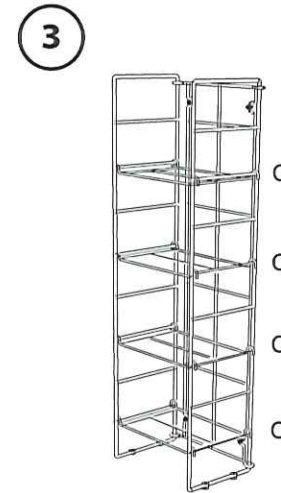

- ③ Insert shelves (C)
Insertar los estantes (C)
Insérez les tablettes (C)

Or / O / Ou

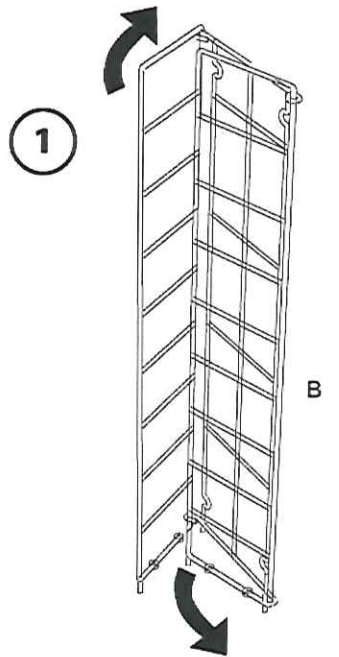

- ① Unfold sections (B)
Desdoblar secciones (B)
Dépliez les sections (B)

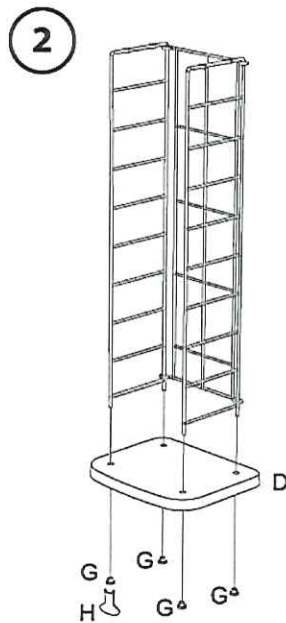

- ② Attach base (D) to (B) with (G) using tool provided (H)
Unir la base (D) a (B) con (G) utilizando la herramienta proporcionada (H)
Fixez la base (D) sur (B) à l'aide de (G) en utilisant l'outil fourni (H)

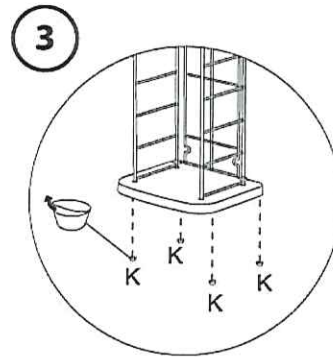

- ③ Attach rubber feet (K) for stabilizing -
Do Not Cover Screw Holes
Poner las patas de hule (K) para la estabilidad -
No tapar los agujeros para los tornillos
Posez les pieds en caoutchouc (K) pour stabiliser -
Ne couvrez pas les trous pour les vis

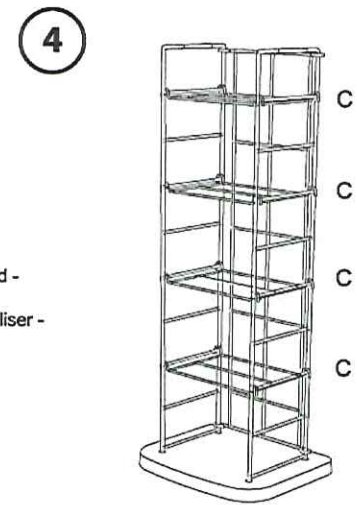

- ④ Insert shelves (C)
Insertar los estantes (C)
Insérez les tablettes (C)

**Safety Strap Instructions: / Instrucciones para la Correa de Seguridad: /
Directives pour installation de la sangle de sécurité:**

Parts List / Lista de Componentes / Liste des pieces:		Qty. / Cant / Qté	Mounting Instructions /Instrucciones de Montadura/ Directives de montage		
①	Nylon Strap Correa de Nilón Sangle de nylon	1	<p>1. Place the mounting strap at the desired position. Mark the position according to the height of your unit. The marks will be the insertion points of the mounting hardware.</p> <p>1. Coloque la correa de montadura en el lugar deseado. Indique la ubicación según la altura de la unidad. Tales marcas servirán de puntos de inserción para la herramienta de montadura.</p> <p>1. Placez la sangle de montage dans la position désirée. Marquez la position en fonction de la hauteur de votre unité. Les marques indiqueront les points d'insertion du dispositif de montage</p>		
②	Wall Anchor Sujetador para la Pared Dispositif d'ancrage mural	1			
③	Dry-wall screw Tornillo para pared de cartón de yeso Vis pour cloison sèche	1			
<p>* Tools needed/ not included * Outils requis/ non fournis * Herramientas requeridas/ no incluidas</p> <table border="0"> <tr> <td>Power Drill Bleistift/Taladro eléctrico Perceuse électrique</td> <td>Phillips screwdriver Desarmador de estrella (Phillips) Tournevis Phillips</td> </tr> </table>			Power Drill Bleistift/Taladro eléctrico Perceuse électrique	Phillips screwdriver Desarmador de estrella (Phillips) Tournevis Phillips	<p>Note: For Safe Mounting, it is essential to use the proper hardware for your wall type (wood, drywall, concrete, etc.) Contact your local hardware store for assistance if necessary. Mount to wood studs whenever possible.</p> <p>NOTA: Para un Montaje Seguro, es esencial usar los implementos adecuados para el tipo de su pared (madera, cartón de yeso, concreto, etc.) Acuda a la ferretería de su localidad para asistencia si es necesario. Instale en los barros siempre que sea posible.</p> <p>REMARQUE : Pour un montage en toute sécurité, il est essentiel d'utiliser le dispositif qui convient à votre mur (cloison sèche, béton, etc.) Communiquez avec votre quincaillerie locale si vous avez besoin d'aide. Montez sur les boulons de bois si possible.</p>
Power Drill Bleistift/Taladro eléctrico Perceuse électrique	Phillips screwdriver Desarmador de estrella (Phillips) Tournevis Phillips				

Using the strap on wire items: only the strap, wall anchor and dry-wall screw are needed. See picture below
 Utilice la correa para los artículos de alambre. Solo se necesitan la correa, el sujetador para la pared y el tornillo para paredes de piedra.
 Utilisation de la sangle pour les articles en métal : vous n'avez besoin que de la sangle, du dispositif d'ancrage mural et des vis pour cloison sèche.
 Voir l'illustration ci-dessous

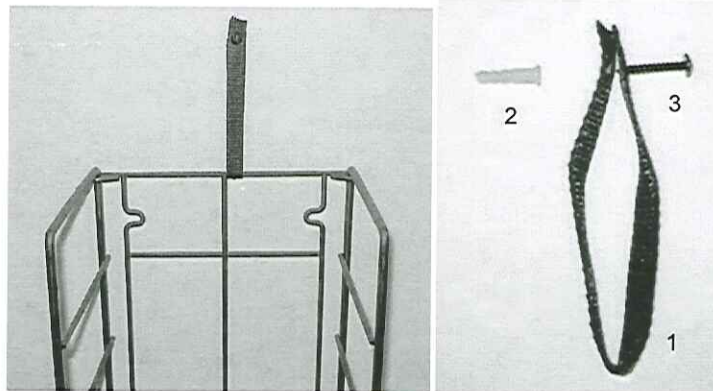

ATLANTIC®

© 2009 Atlantic Inc. Santa Fe Springs, CA, U.S.A.
 U.S. AND OTHER FOREIGN PATENTS PENDING
 ALL RIGHTS RESERVED
 www.atlantic-inc.com MADE IN CHINA

Patentes de los EUA y países extranjeros en trámite /
 Brevets en cours pour les États-Unis et autres pays

Derechos Reservados / Tous droits réservés /

Hecho en China / Fabriqué en Chine /

R 1.0 090720 #78205090

