

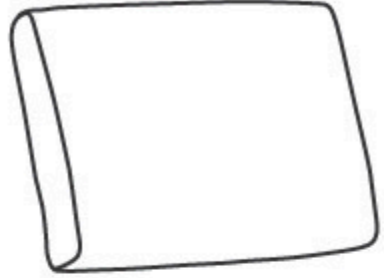

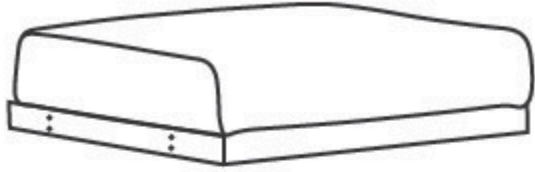

MODEL:BR8111S

(1)X1	(2)X1
 BACK & ARM	 SEAT
(3)X1	(4)X1
 LEFT FRAME	 RGHT FRAME
<p>(A)*8   M6*36 SEAT SCREW</p> <p>(B)*4  M6*30 BACK SCREW</p> <p>(C)*1  ALLEN KEY</p>	

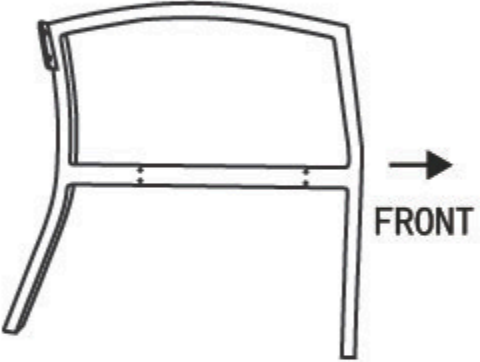
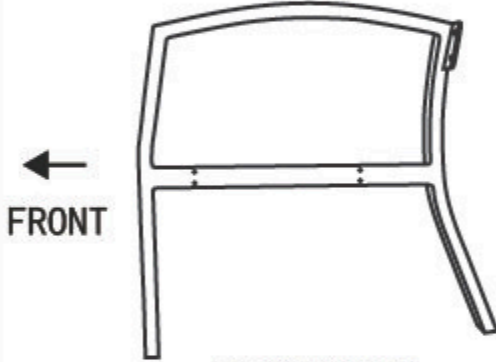
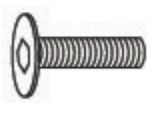

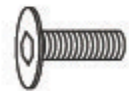
**Insert and loosely tighten all screws. When assembly is completed, fully tighten all screws before using. This chair is only intended for sitting. Any other use will void the warranty.**

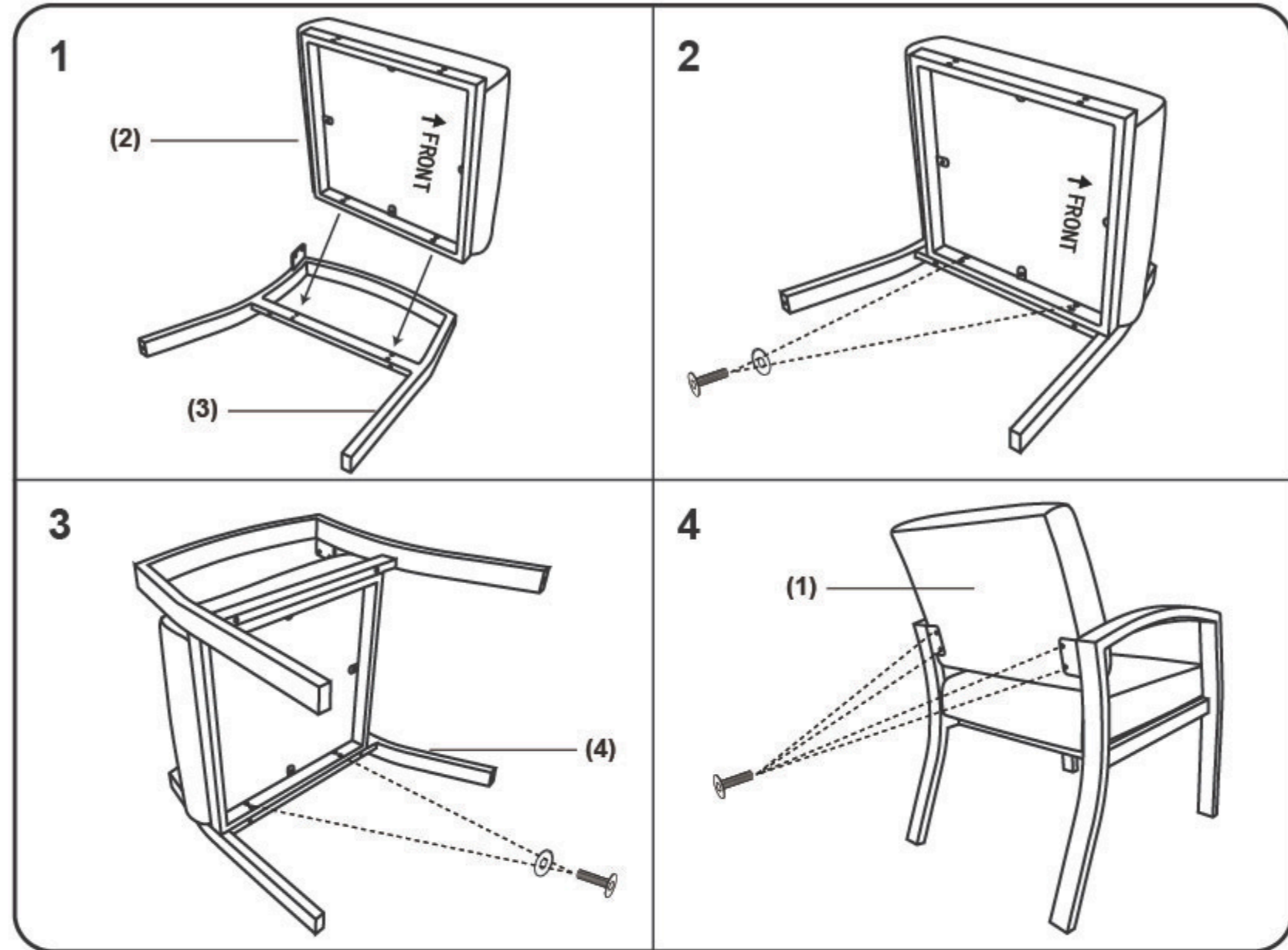
Adjust glides at the bottom of each leg to prevent chair from wobbling.

