

# 88 5993 88

## Soda Shoppe Stool

### Black Vinyl

#### IMPORTANT NOTE

Carefully remove all the parts from the carton and put them individually on a soft cloth to prevent scratches or other damages occurring to the wood parts.

We have taken great care in the design of this product and request that you carefully and strictly follow our assembly instructions to ensure a completed product as it was designed.



Casual Attire For Today's Home

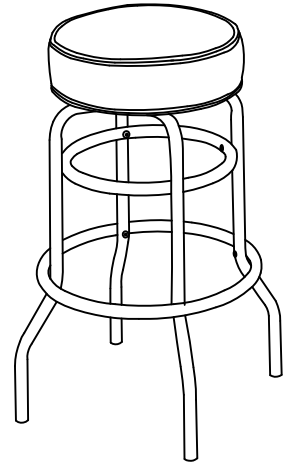

## Part List

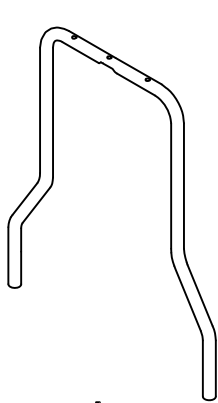

**A.  
Leg**  
1 pc.

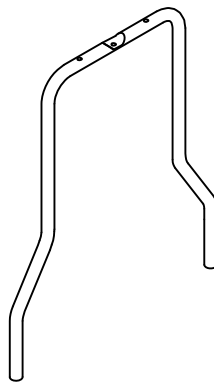

**B.  
Leg**  
1 pc.



**C.  
Seat**  
1 pc.

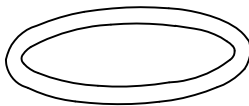

**D.  
Foot Rest**  
1 pc.

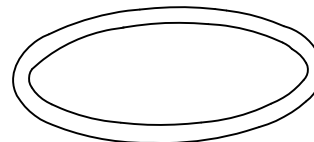

**E.  
Foot Rest**  
1 pc.

## Hardware List

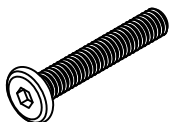

**Bolt. (small)**  
12 pcs.(+1 extra)

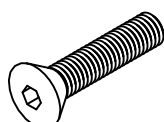

**Bolt. (large)**  
1 pc.(+1 extra)



**Nut.**  
1 pc.(+1 extra)



**Key Wrench.**  
1 pcs.



**Hex Wrench.**  
1 pcs.

Tools Required For Assembly : Phillips screwdriver

Home Styles Consumer Assistance Line 888-680-7460 and 877-831-0319  
[servicedesk@homestyles-furniture.com](mailto:servicedesk@homestyles-furniture.com)

# Assembly Instructions 2/2

## IMPORTANT

Do not tighten up all the bolts until each part is properly assembled.

## STEP 1

Attach Leg (A) to Leg (B), using Bolt (large) and Nut.

Attach Foot Rest (D) to the unit with Bolts (small) 4X.

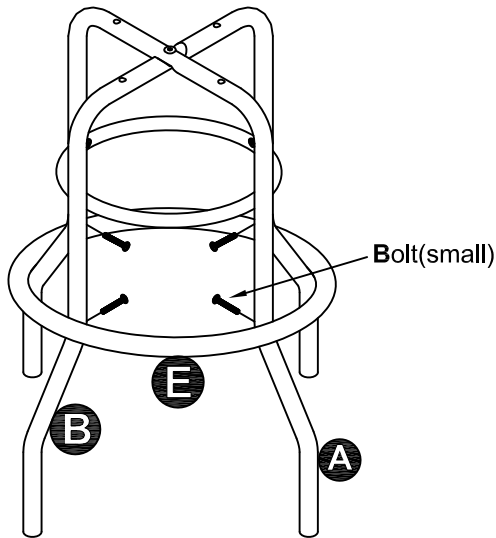
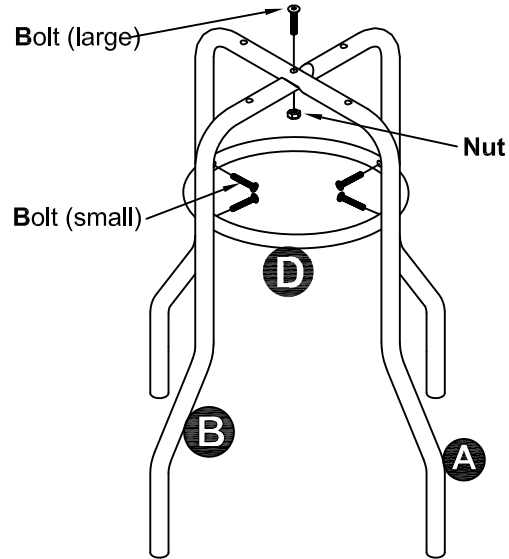

## STEP 2

Place Foot Rest (E) onto the assembled unit in STEP 1 the with Bolt (small) 4X as shown.

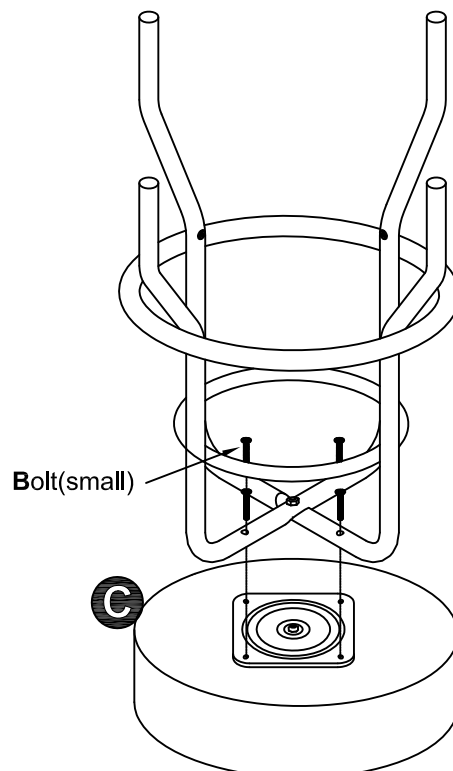

## STEP 3

Turn over the unit and place it onto Seat (C) with Bolt (small) 4X as shown.